











| | | | | | | |
|---|---|---|--|--|--|--|
| <p>A-01 Клемма стартера(E)</p>    | <p>A-02 Генератор (E)</p>   | <p>A-02 Генератор (E)</p>   | <p>A-03 Реле блокировки стартера (D)</p>    | | | |
| | | | | | | |
| | | | | | | |



B1-01 ECU(EM)

| | | | | | | | | | | | | | | | | | | |
|----|-----|-----|-----|-----|-----|-----|-----|-----|-----|-----|-----|-----|-----|-----|-----|-----|----|----|
| 63 | W/B | Y | BR | V | L/Y | R/B | L/B | V | W/G | V/R | * | G/B | EM | L | B | B | LG | 81 |
| | W/B | W/B | V/L | B/V | W | * | GW | B | * | B | * | P | * | G/R | O/L | G/R | * | 62 |
| 44 | | | | | | | | | | | | | | | | | | |
| 25 | * | P/L | L/B | V/R | G/B | * | G | O/L | P/G | R/W | L/W | G/Y | G/R | V/Y | Y/R | * | * | 43 |
| | | | | | | | | | | | | | | | | | | |
| 6 | | | | | | | | | | | | | | | | | | |

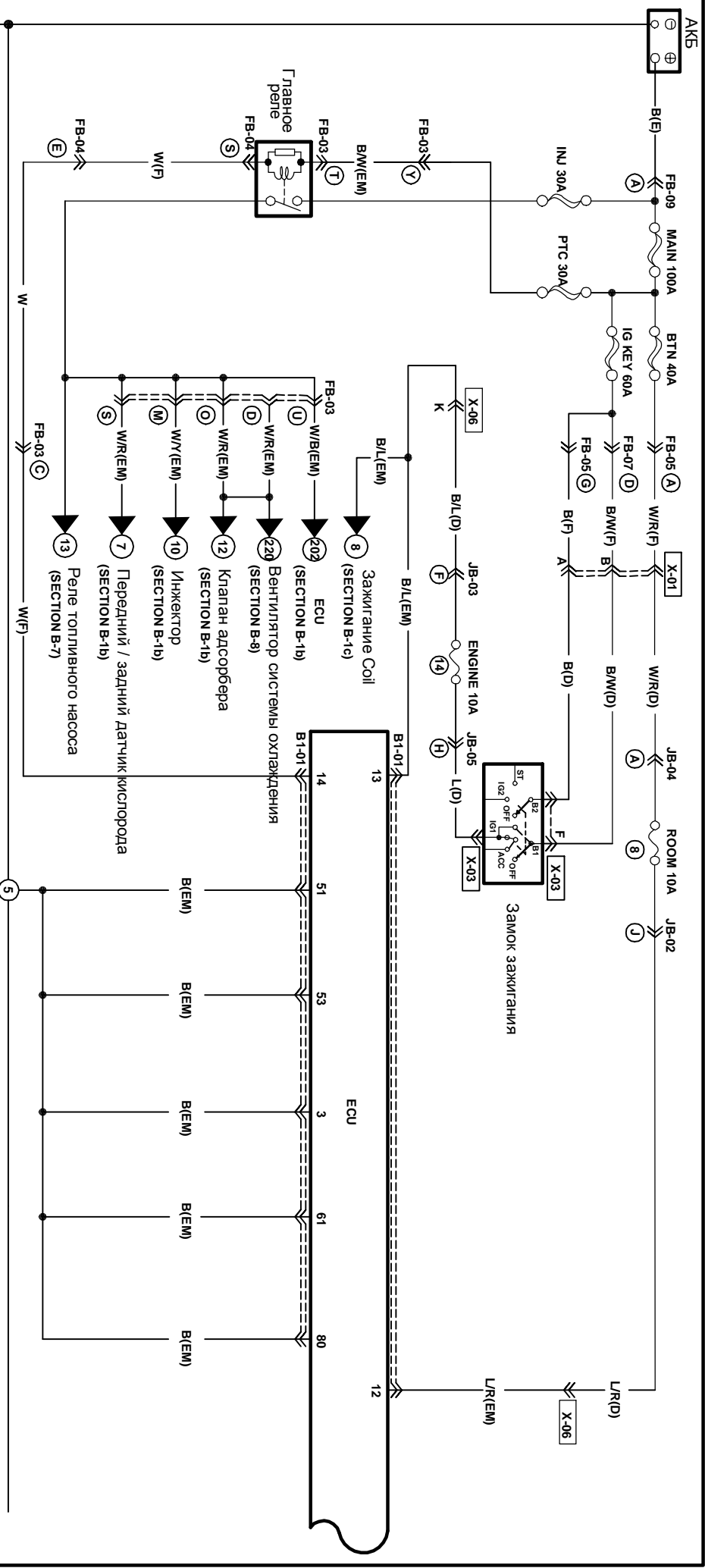
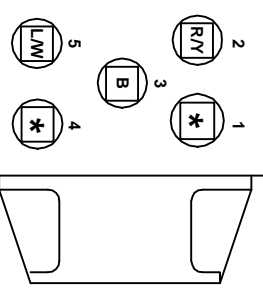

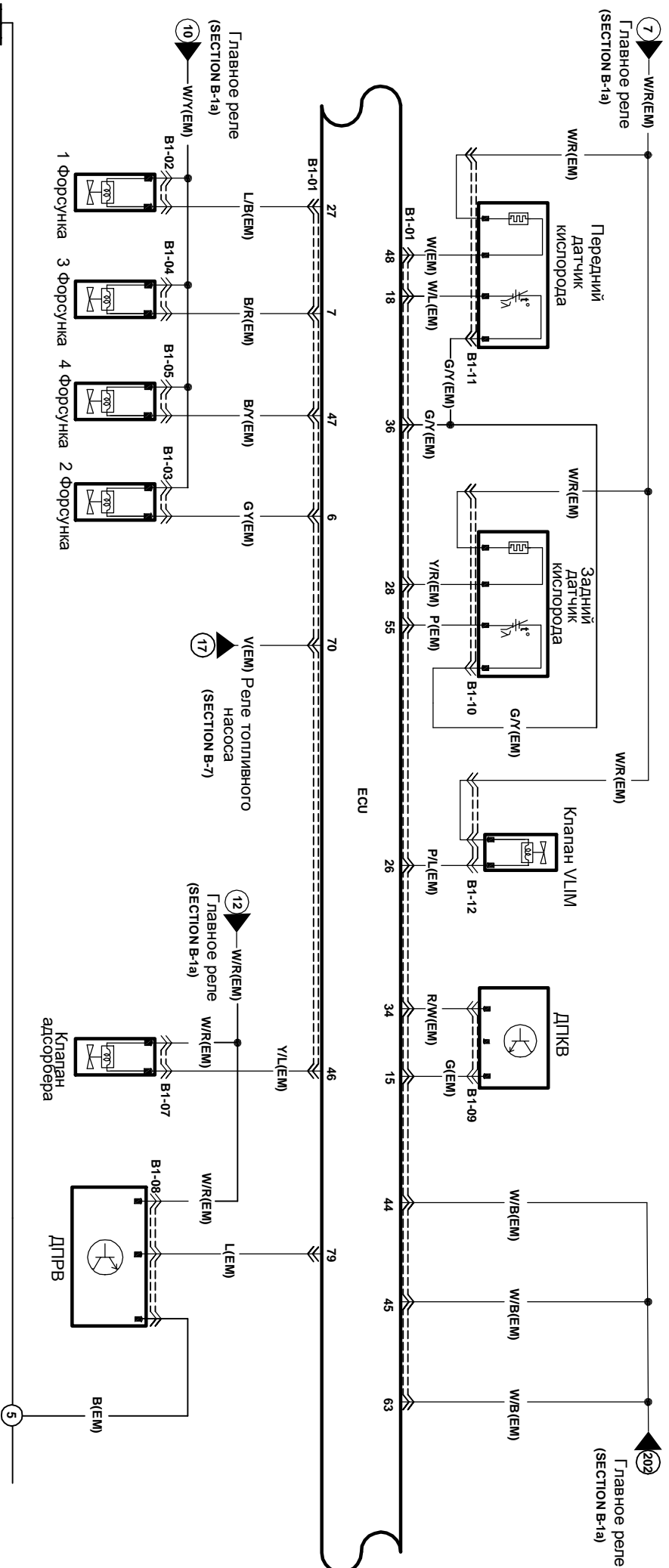

B1-01 Кюлодка ЭВУ(EM)

| | | | | | | | | | | | | | | | | | | | | |
|----|-----|-----|-----|-----|-----|-----|-----|-----|-----|-----|-----|-----|-----|-------|-----|-----|---|---|-----|----|
| 63 | W/B | Y | BR | V | L/Y | R/B | L/B | V | W/G | V/R | * | G/B | B/W | L/G/B | * | L | B | B | L/G | 81 |
| | W/B | Y/L | V/L | W | G/W | B | * | V | * | B | * | P | * | O/L | G/R | * | B | O | | 62 |
| 44 | | | | | | | | | | | | | | | | | | | | 43 |
| 25 | * | P/L | L/B | V/R | G/B | * | G | O/L | P/G | R/W | L/W | G/Y | G/R | * | V/Y | Y/R | * | * | * | 43 |
| | G/Y | B/R | V/W | * | * | * | * | L/R | B/L | W | G | P/B | B/Y | W/L | R | L/R | * | * | * | 24 |
| 6 | | | | | | | | | | | | | | | | | | | | 24 |

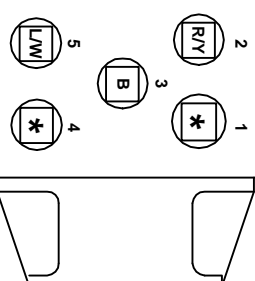

| | | | | | | | |
|------------------------|--|------------------|--|------------------|--|------------------|--|
| B1-02 1 Форсунка | | B1-03 2 Форсунка | | B1-04 3 Форсунка | | B1-05 4 Форсунка | |
| B1-07 Клапан адсорбера | | B1-08 ДПРВ | | B1-09 ДПКВ | | B1-10 Задний ДК | |
| B1-11 Передний ДК | | | | B1-12 ????????? | | | |

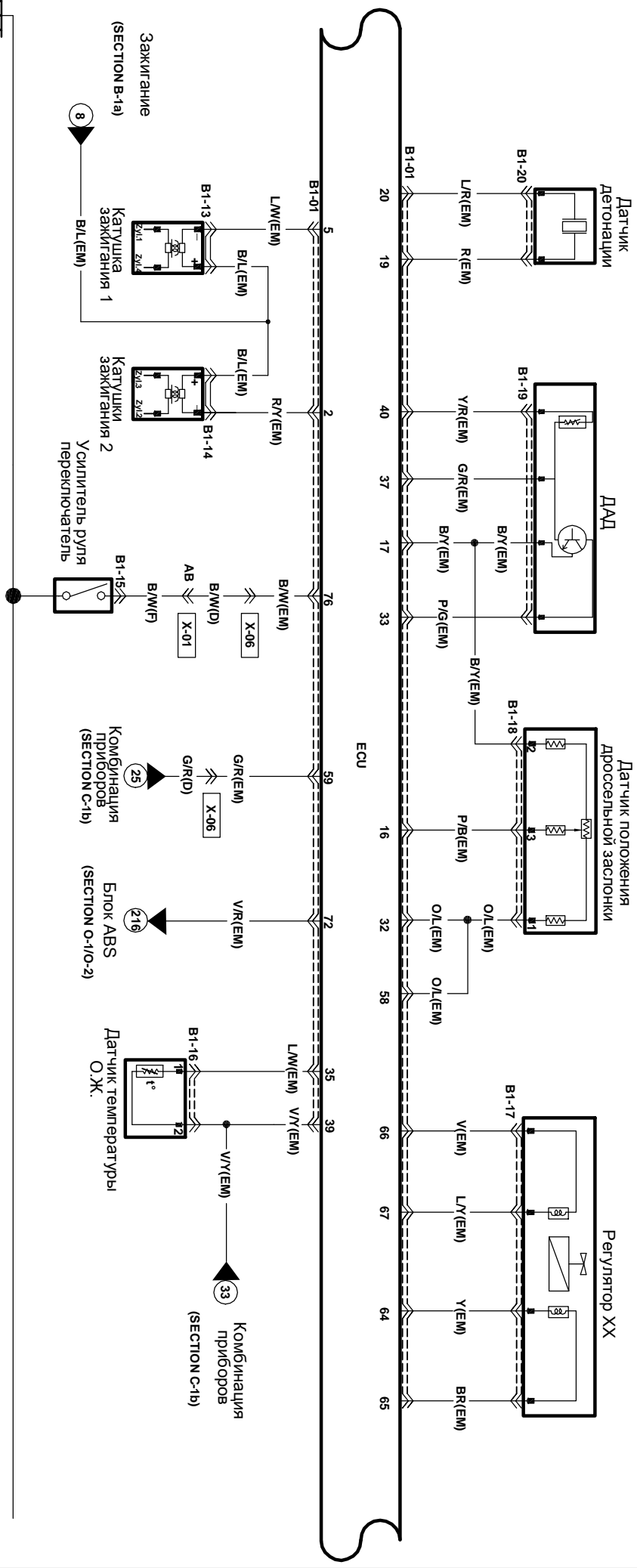

В1-01 Кодовка ЭБУ(ЕМ)

| | | | | | | | | | | | | | | | | | | | | |
|----|-----|-----|-----|-----|-----|-----|-----|------|-----|-----|------|-----|------|------|-----|-----|---|---|----|----|
| 63 | W/B | Y | BR | V | L/Y | R/B | L/B | V | W/G | V/R | * | G/B | B/W | LG/B | * | L | B | B | LG | 81 |
| 44 | W/B | BR | V | L/Y | R/B | L/B | V | W/G | V/R | * | G/B | B/W | LG/B | * | L | B | B | B | LG | 62 |
| 25 | W/B | Y/L | W | * | G/W | B | * | V | * | P | * | G/B | B/W | LG/B | * | L | B | B | LG | 43 |
| 6 | GY | BR | W/W | * | G/B | * | G | OL/L | P/G | R/W | LG/W | G/Y | G/R | * | V/Y | Y/R | * | * | * | 24 |

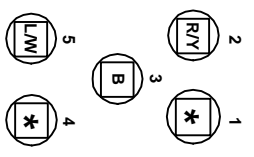

| | | | | | |
|--|-------------------------------|--|-----------------------------------|--|---|
| | В1-13 Кат. зажигания 1 | | В1-14 Кат. зажигания 2 | | В1-15 Усилитель руля переключатель |
| | В1-16 Датчик Т. ОЖ | | В1-17 Регулятор ХХ | | В1-18 ДППДЗ |
| | В1-19 ДАД | | В1-20 Датчик герметичности | | |

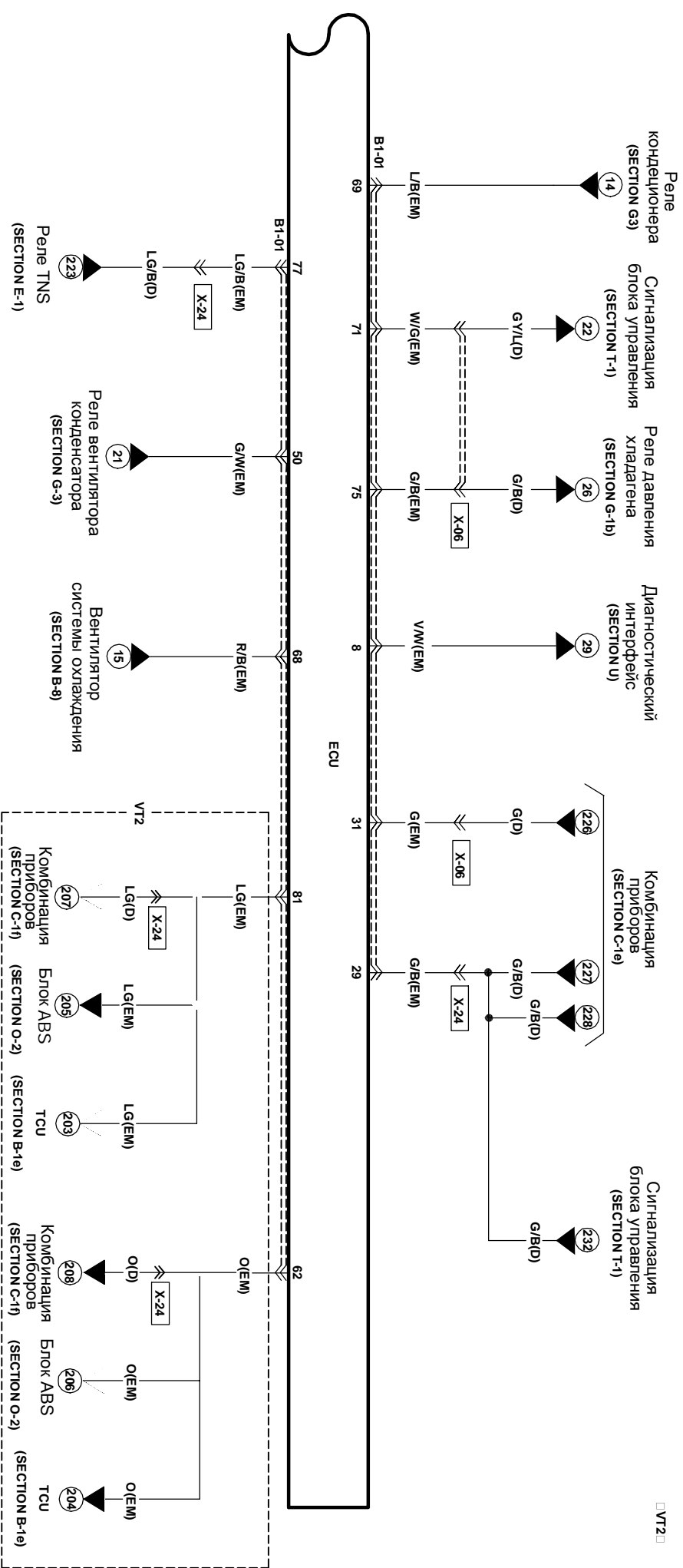

777
B-1-01 Кодовка ЭБУ(EM)

| | | | | | | | | | | | | | | | | | | | |
|----|-------|-----|-----|-----|----|-----|-----|-----|-----|-----|-----|-----|-----|------|-----|-----|---|----|----|
| 63 | W/B | Y | BR | V | LV | R/B | L/B | V | W/G | V/R | * | G/B | BW | LG/B | * | L | B | LG | 81 |
| 44 | W/B | W/B | Y/L | B/Y | W | * | GW | B | * | B | * | G/B | BW | LG/B | * | L | B | LG | 62 |
| 25 | * P/L | L/B | V/R | G/B | * | * | G | O/L | P/G | R/W | LW | GW | G/R | * | V/Y | Y/R | * | * | 43 |
| 6 | GY | B/R | V/W | * | * | * | L/R | B/L | W | G | P/B | B/Y | W/L | R | L/R | * | * | * | 24 |

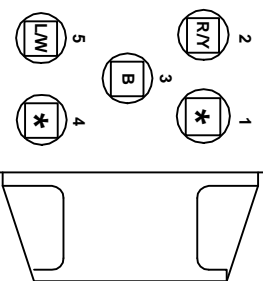

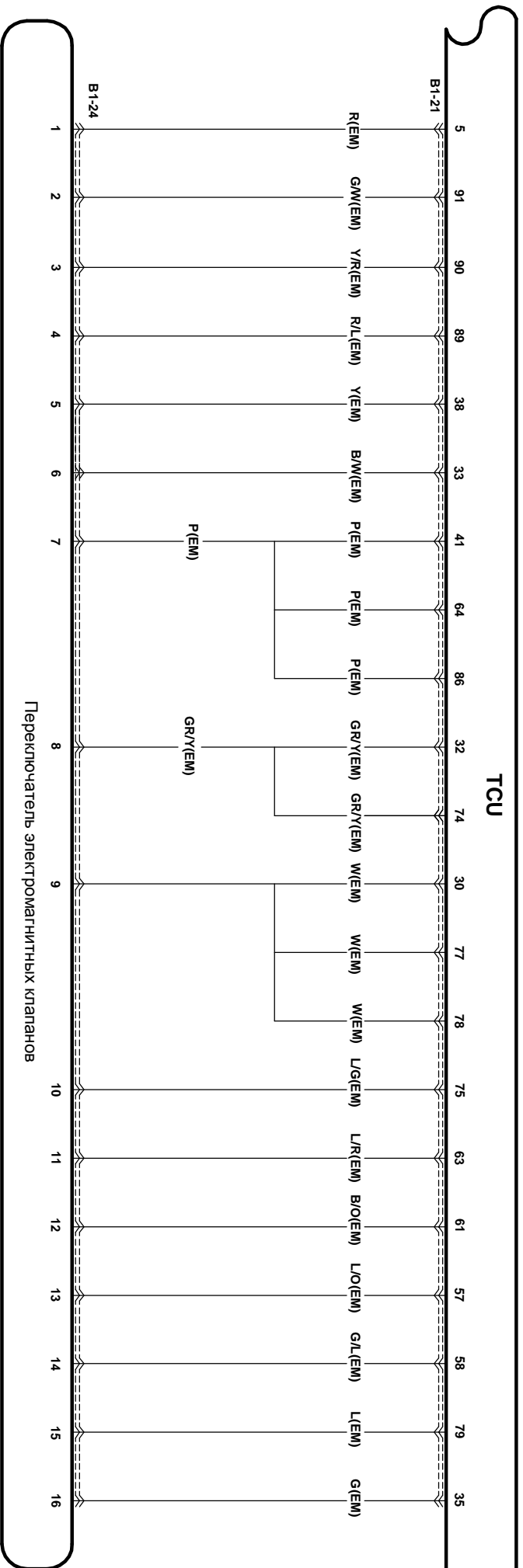

B1-21 Кодовка TCU(EM)

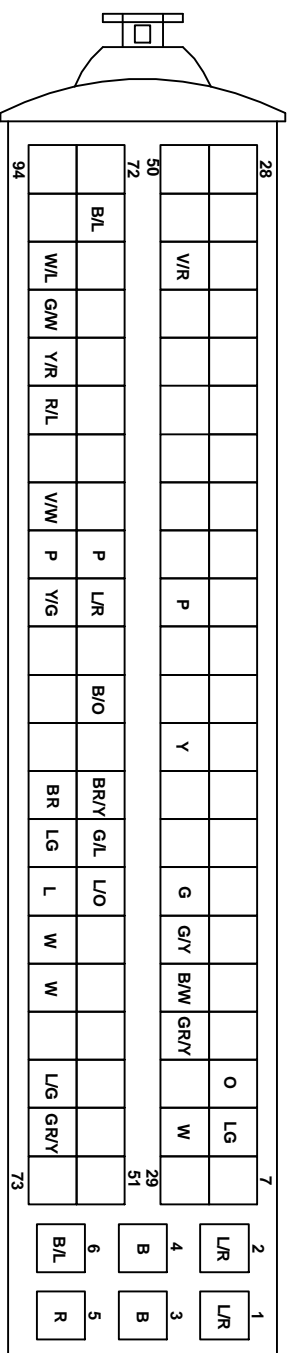

B1-24 Shift электромагнитный клапан

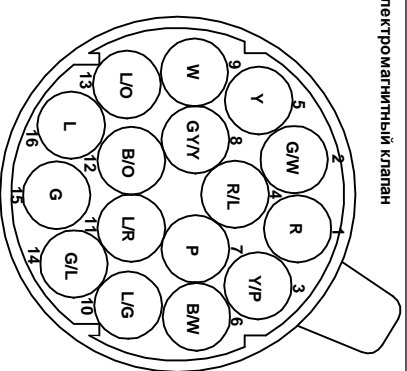

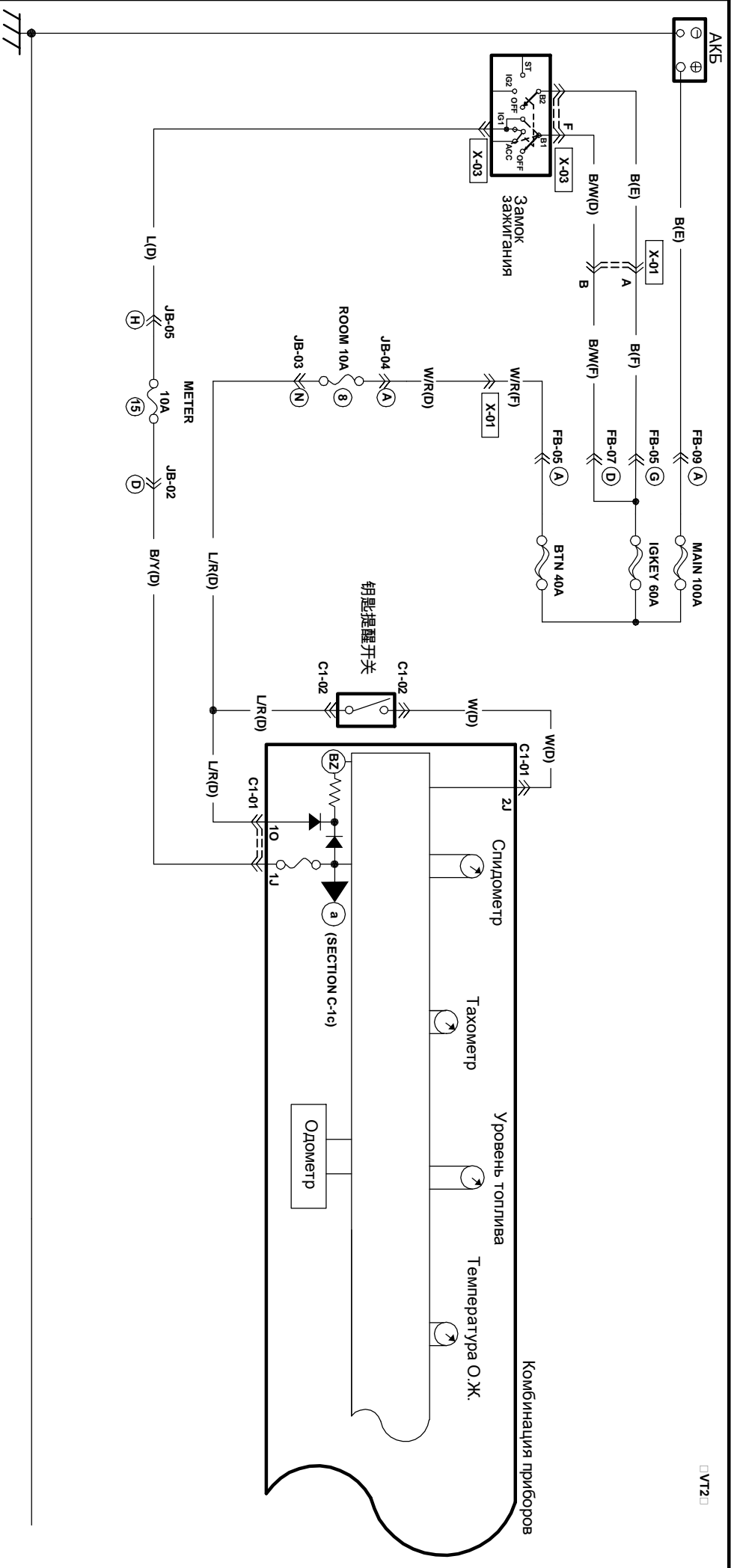

C1-01 Комбинация приборов

EOBD

C1-01 Комбинация приборов(D)

Баз EOBD

C1-02 ?????(D)

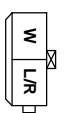

| | | | | | | | | | |
|------|-----|-----|------|-----|------|------|-----|-----|-----|
| 1Q | 1O | 1M | 1K | 1I | 1G | 1E | 1C | 1A | |
| BR | L/R | W/L | Y/B | B/L | BR/B | LG/B | G/B | B/O | |
| BR/R | L | L/O | LG/R | B/Y | Y/R | R/W | B | GW | |
| 1R | 1P | 1N | 1L | 1J | 1H | 1F | 1D | 1B | |
| 20 | 2M | 2K | 2I | 2G | 2E | 2C | 2A | | |
| * | * | * | * | * | * | * | O | LG | |
| * | L/R | * | * | * | * | * | | R/L | |
| 2P | 2N | 2L | 2J | 2H | 2F | 2D | 2B | | |
| 3S | 3Q | 3O | 3M | 3K | 3I | 3G | 3E | 3C | 3A |
| R/Y | R/B | G/R | * | * | B/O | GY/B | V/Y | GY | Y |
| P | * | G | * | * | G/B | P/L | * | * | V/W |
| 3T | 3R | 3P | 3N | 3L | 3J | 3H | 3F | 3D | 3B |

| | | | | | | | | | |
|------|-----|-----|------|-----|------|------|-----|-----|-----|
| 1Q | 1O | 1M | 1K | 1I | 1G | 1E | 1C | 1A | |
| BR | L/R | W/L | Y/B | B/L | BR/B | LG/B | G | B/O | |
| BR/R | L | L/O | LG/R | B/Y | Y/R | R/W | B | GW | |
| 1R | 1P | 1N | 1L | 1J | 1H | 1F | 1D | 1B | |
| 20 | 2M | 2K | 2I | 2G | 2E | 2C | 2A | | |
| * | * | * | * | * | * | * | O | LG | |
| * | L/R | * | * | * | * | * | | R/L | |
| 2P | 2N | 2L | 2J | 2H | 2F | 2D | 2B | | |
| 3S | 3Q | 3O | 3M | 3K | 3I | 3G | 3E | 3C | 3A |
| R/Y | R/B | G/R | * | * | B/O | GY/B | V/Y | GY | Y |
| P | * | G | * | * | G/B | P/L | * | * | V/W |
| 3T | 3R | 3P | 3N | 3L | 3J | 3H | 3F | 3D | 3B |

□ VT2 □

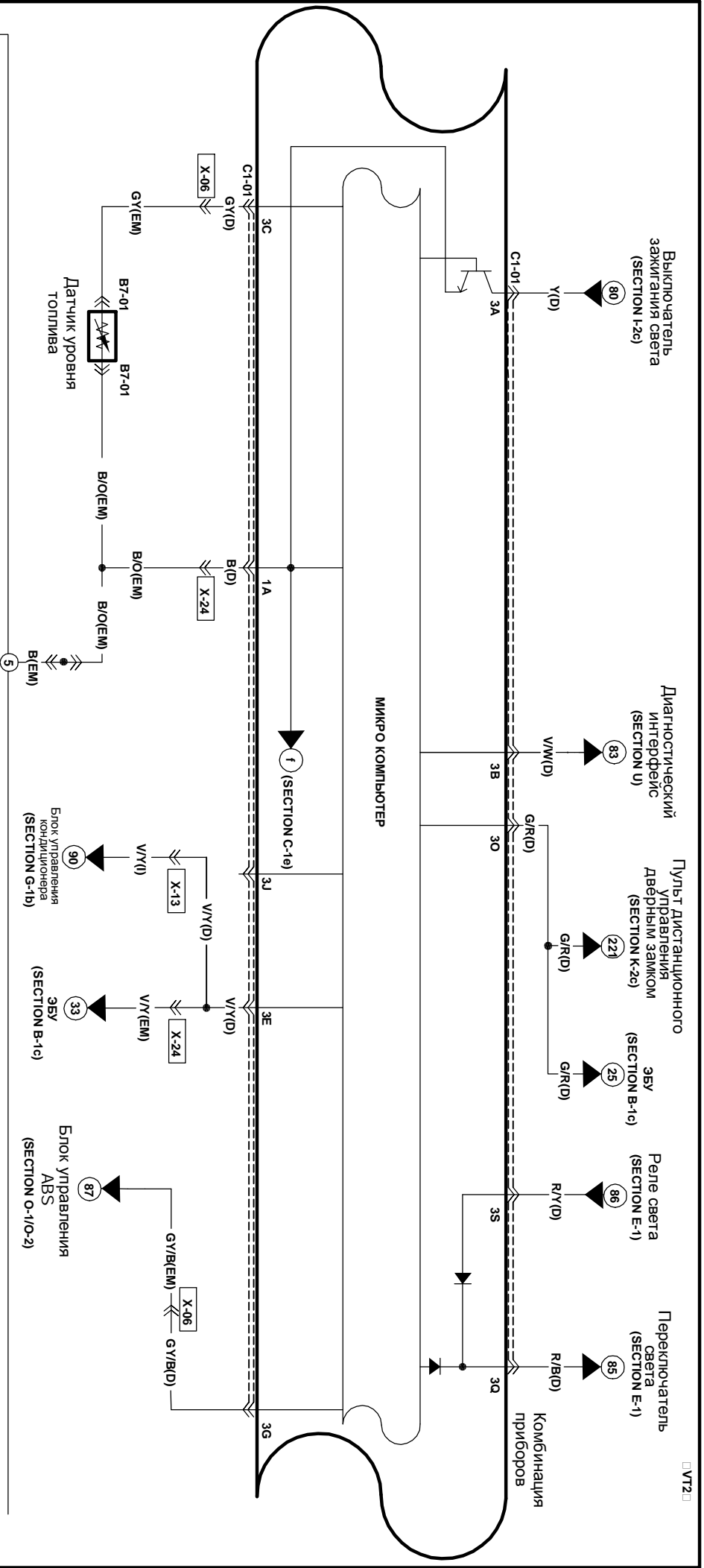

С-1-01 Комбинация приборов(D) EOBD

С-1-01 Комбинация приборов(D) Без EOBD

B7-01 Датчик уровня топлива (D)

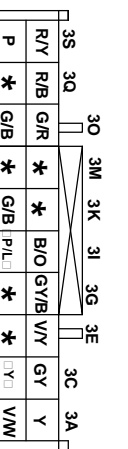
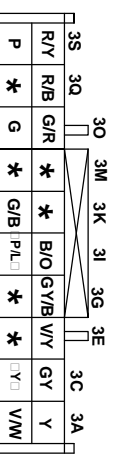
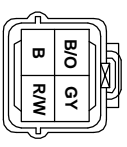
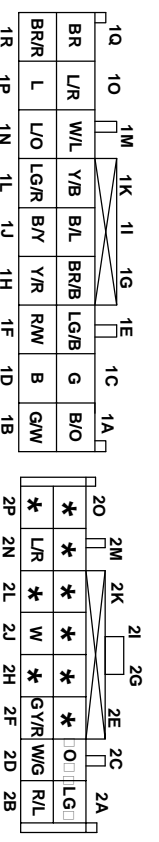
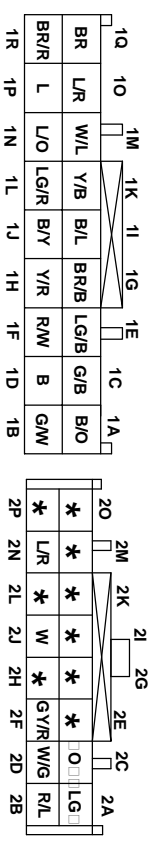

□ VT2 □

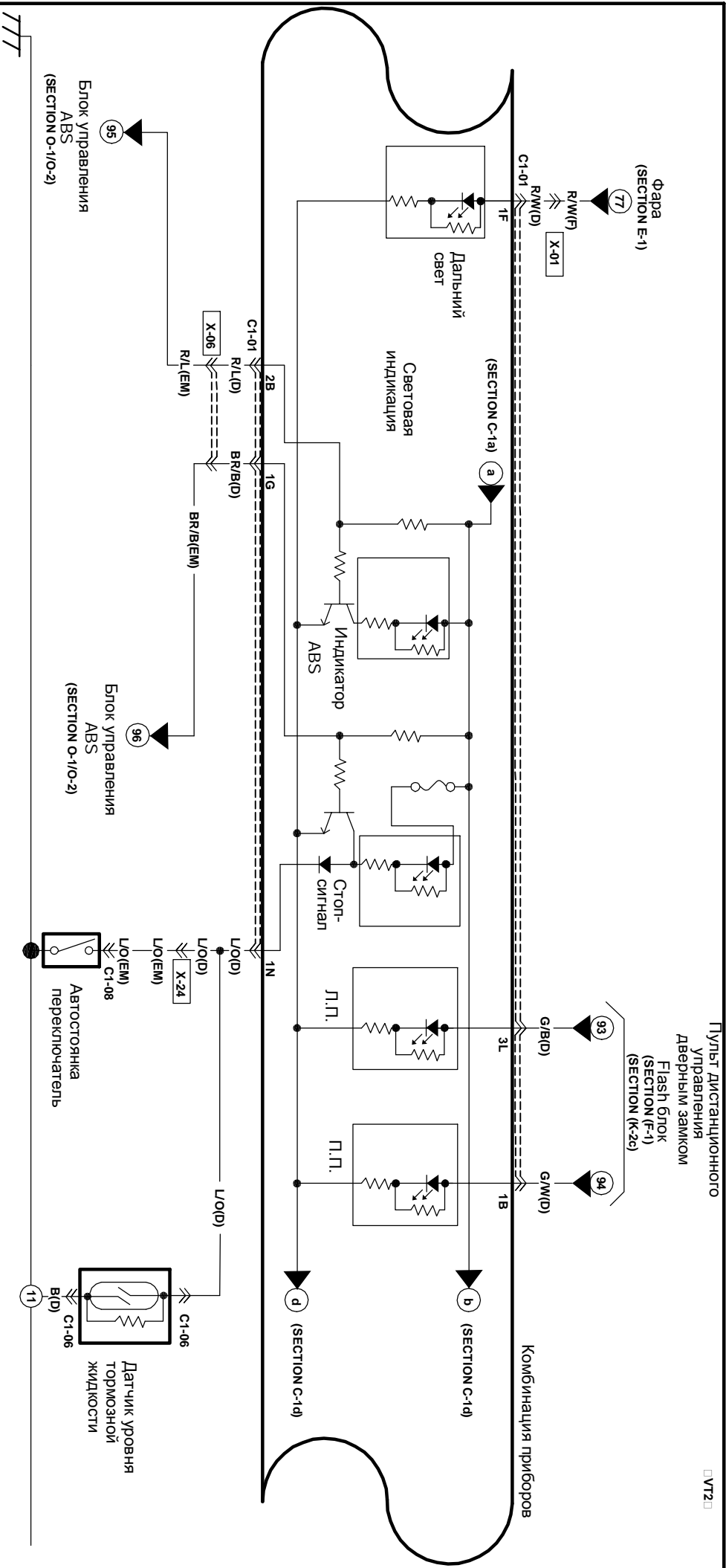

С1-01 Комбинация приборов(Д) EОВД

С1-01 Комбинация приборов(Д) Без EОВД

С1-06 Датчик уровня Т.Ж

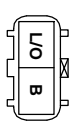

С1-08 Автоматическая выключатель (3М)



| | | | | | | | | | | | | | | | | | | | |
|------|-----|-----|------|-----|-------|------|-----|-----|------|-----|-----|------|-----|-------|------|-----|-----|----|----|
| 1Q | 10 | 1M | 1K | 1I | 1G | 1E | 1C | 1A | 1Q | 10 | 1M | 1K | 1I | 1G | 1E | 1C | 1A | | |
| BR | L/R | W/L | Y/B | B/L | BR/B | LG/B | G/B | B/O | BR | L/R | W/L | Y/B | B/L | BR/B | LG/B | G/B | B/O | | |
| BR/R | L | L/O | LG/R | B/Y | Y/R | R/W | B | G/W | BR/R | L | L/O | LG/R | B/Y | Y/R | R/W | B | G/W | | |
| 1R | 1P | 1N | 1L | 1J | 1H | 1F | 1D | 1B | 1R | 1P | 1N | 1L | 1J | 1H | 1F | 1D | 1B | | |
| 2P | 2N | 2L | 2J | 2H | 2F | 2D | 2B | | 2P | 2N | 2L | 2J | 2H | 2F | 2D | 2B | | | |
| 3S | 3Q | 3M | 3K | 3I | 3G | 3E | 3C | 3A | 3S | 3Q | 3M | 3K | 3I | 3G | 3E | 3C | 3A | | |
| R/Y | R/B | G/R | * | B/O | G/Y/B | V/Y | G/Y | Y | R/Y | R/B | G/R | * | B/O | G/Y/B | V/Y | G/Y | Y | | |
| P | * | G | G/B | P/L | * | * | Y | V/W | P | * | G | G/B | P/L | * | * | Y | V/W | | |
| 3T | 3R | 3P | 3N | 3L | 3J | 3H | 3F | 3D | 3B | 3T | 3R | 3P | 3N | 3L | 3J | 3H | 3F | 3D | 3B |

| | | | | | | | | | | | | | | | | | | | |
|------|-----|-----|------|-----|-------|------|-----|-----|------|-----|-----|------|-----|-------|------|-----|-----|----|----|
| 1Q | 10 | 1M | 1K | 1I | 1G | 1E | 1C | 1A | 1Q | 10 | 1M | 1K | 1I | 1G | 1E | 1C | 1A | | |
| BR | L/R | W/L | Y/B | B/L | BR/B | LG/B | G | B/O | BR | L/R | W/L | Y/B | B/L | BR/B | LG/B | G | B/O | | |
| BR/R | L | L/O | LG/R | B/Y | Y/R | R/W | B | G/W | BR/R | L | L/O | LG/R | B/Y | Y/R | R/W | B | G/W | | |
| 1R | 1P | 1N | 1L | 1J | 1H | 1F | 1D | 1B | 1R | 1P | 1N | 1L | 1J | 1H | 1F | 1D | 1B | | |
| 2P | 2N | 2L | 2J | 2H | 2F | 2D | 2B | | 2P | 2N | 2L | 2J | 2H | 2F | 2D | 2B | | | |
| 3S | 3Q | 3M | 3K | 3I | 3G | 3E | 3C | 3A | 3S | 3Q | 3M | 3K | 3I | 3G | 3E | 3C | 3A | | |
| R/Y | R/B | G/R | * | B/O | G/Y/B | V/Y | G/Y | Y | R/Y | R/B | G/R | * | B/O | G/Y/B | V/Y | G/Y | Y | | |
| P | * | G | G/B | P/L | * | * | Y | V/W | P | * | G | G/B | P/L | * | * | Y | V/W | | |
| 3T | 3R | 3P | 3N | 3L | 3J | 3H | 3F | 3D | 3B | 3T | 3R | 3P | 3N | 3L | 3J | 3H | 3F | 3D | 3B |

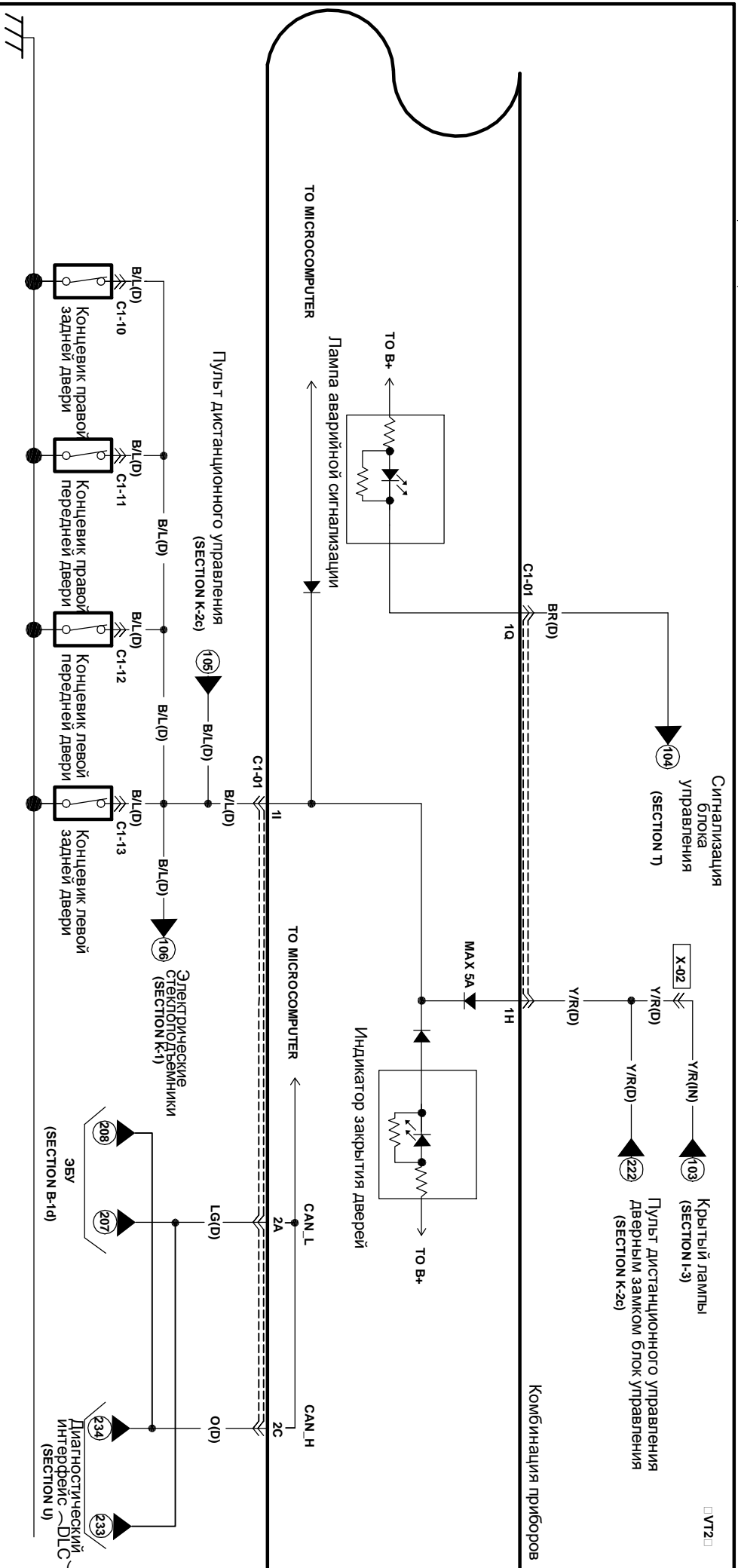

С-1-01 Комбинация приборов(D) EOV D

С-1-01 Комбинация приборов(D) Без EOV D

С-1-10 Концевик правод
задней двери
(B/L)

С-1-11 Концевик правод
передней двери
(B/L)

С-1-12 Концевик левод
передней двери
(B/L)

С-1-13 Концевик левод
задней двери
(B/L)

| | | | | | | | | | |
|------|-----|-----|------|-----|-------|-------|-----|-----|----|
| 1Q | 1M | 1K | 1I | 1G | 1E | 1C | 1A | | |
| BR | LR | WL | Y/B | B/L | BR/B | Lg/B | G/B | B/O | |
| BR/R | L | L/O | Lg/R | B/Y | Y/R | R/W | B | G/W | |
| 1R | 1P | 1N | 1L | 1J | 1H | 1F | 1D | 1B | |
| 20 | 2M | 2K | 2I | 2G | 2E | 2C | 2A | | |
| * | * | * | * | * | * | O | Lg | | |
| * | * | * | * | * | * | G/Y/R | W/G | R/L | |
| 2P | 2N | 2L | 2J | 2H | 2F | 2D | 2B | | |
| 30 | 3M | 3K | 3I | 3G | 3E | 3C | 3A | | |
| R/Y | R/B | G/R | * | B/O | G/Y/B | V/Y | G/Y | Y | |
| P | * | G | G/B | P/L | * | Y | V/W | | |
| 3T | 3R | 3P | 3N | 3L | 3J | 3H | 3F | 3D | 3B |

| | | | | | | | | | |
|------|-----|-----|------|-----|-------|-------|-----|-----|----|
| 1Q | 1M | 1K | 1I | 1G | 1E | 1C | 1A | | |
| BR | LR | WL | Y/B | B/L | BR/B | Lg/B | G | B/O | |
| BR/R | L | L/O | Lg/R | B/Y | Y/R | R/W | B | G/W | |
| 1R | 1P | 1N | 1L | 1J | 1H | 1F | 1D | 1B | |
| 20 | 2M | 2K | 2I | 2G | 2E | 2C | 2A | | |
| * | * | * | * | * | * | O | Lg | | |
| * | * | * | * | * | * | G/Y/R | W/G | R/L | |
| 2P | 2N | 2L | 2J | 2H | 2F | 2D | 2B | | |
| 30 | 3M | 3K | 3I | 3G | 3E | 3C | 3A | | |
| R/Y | R/B | G/R | * | B/O | G/Y/B | V/Y | G/Y | Y | |
| P | * | G | G/B | P/L | * | Y | V/W | | |
| 3T | 3R | 3P | 3N | 3L | 3J | 3H | 3F | 3D | 3B |

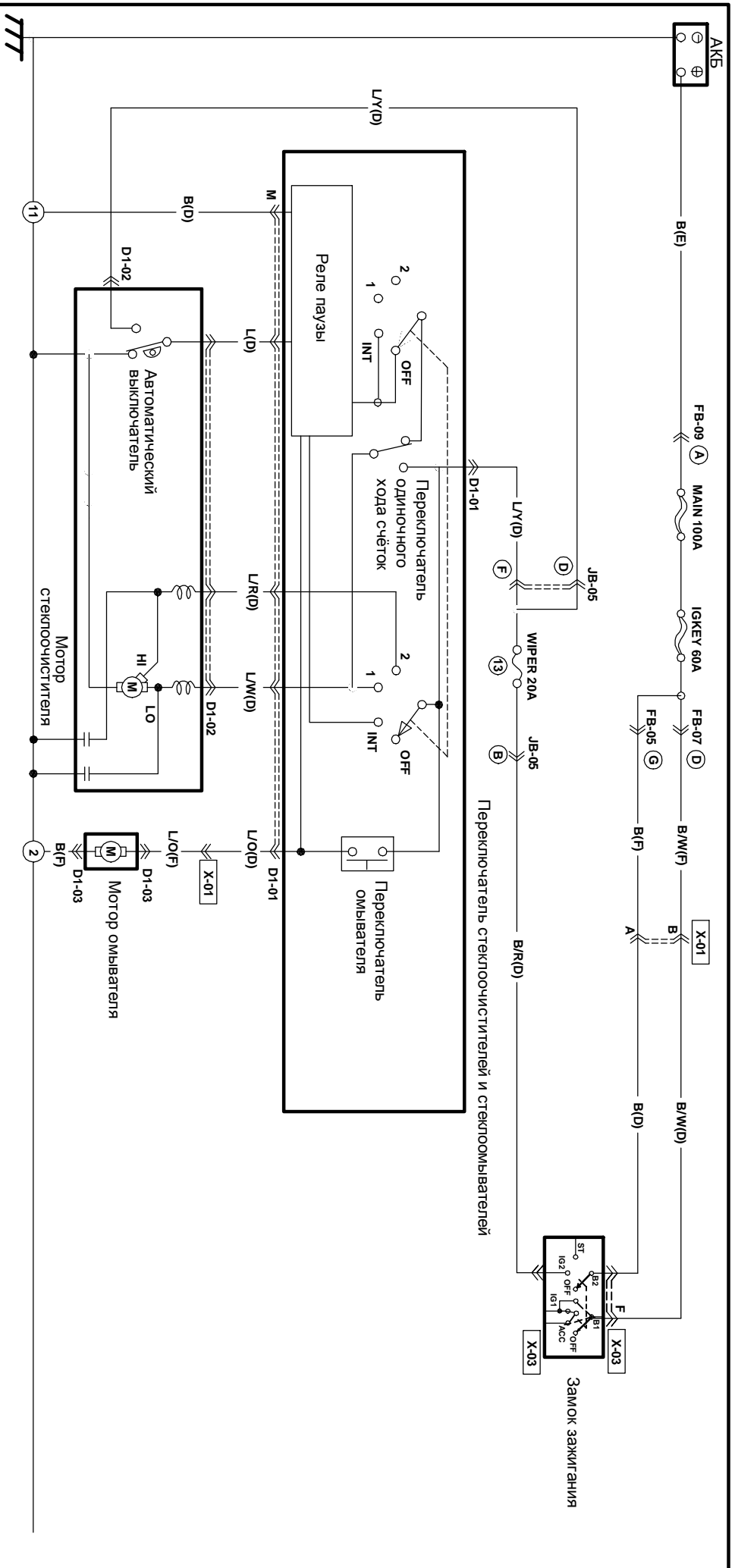

D1-01 Переключатель стеклоочистителя и стеклоомывателя (D)

D1-02 Мотор стеклоочистителя (D)

D1-03 Мотор омывателя (D)

| | | | | | |
|-----|---|-----|-----|------|---|
| M | | | | | |
| L/R | B | L/W | P/L | BR/B | B |
| * | * | * | ⊗ | * | * |
| F | | | | | |

| | |
|-----|-----|
| L/W | L/R |
| L/Y | L |

| |
|-----|
| B |
| L/O |

Задний стеклоочиститель и омыватель (Хечбек)

D-2

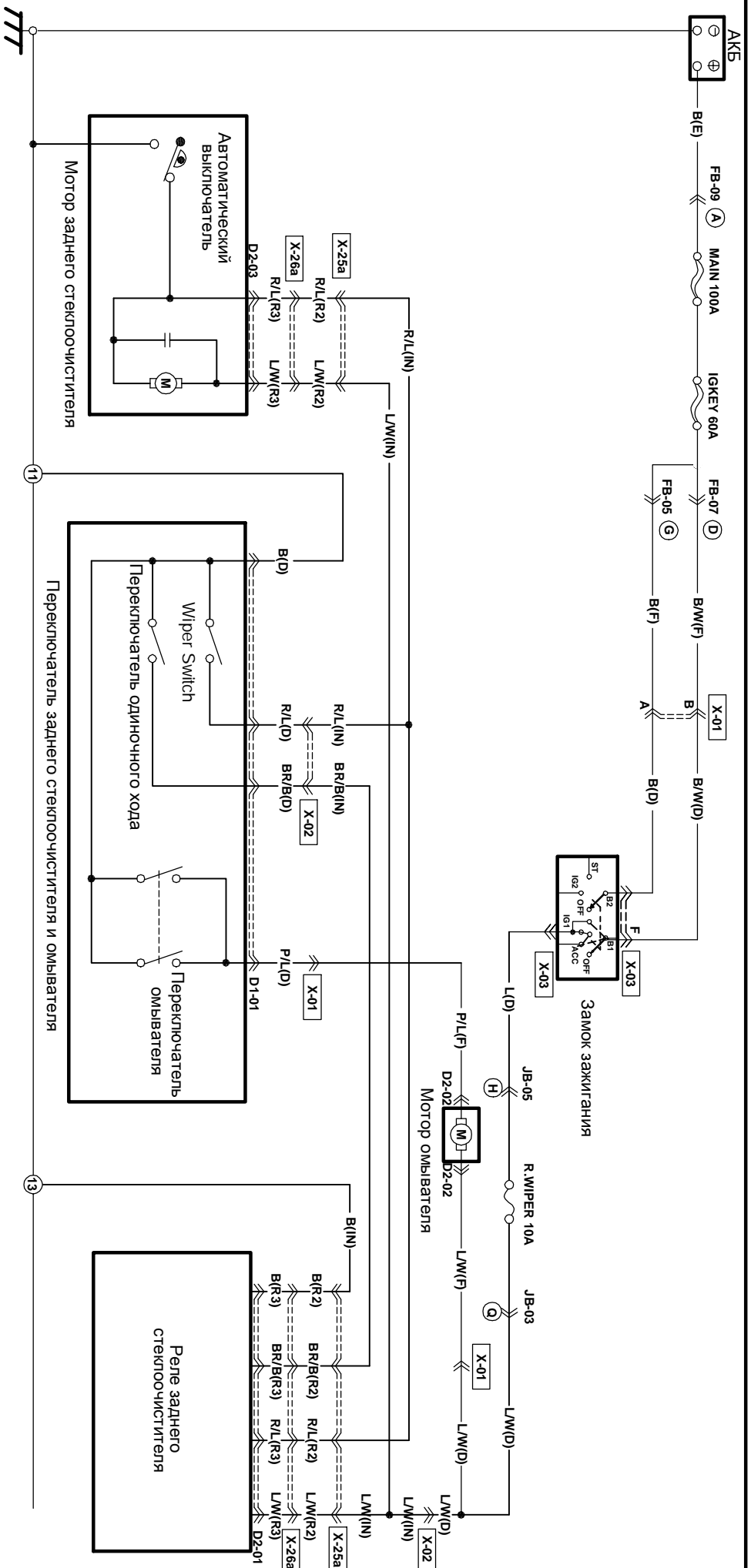

D2-01 Реле заднего стеклоочистителя(R3)

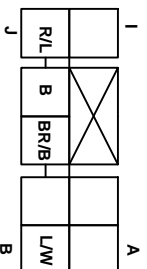

D2-02 Мотор омывателя(F)



D2-03 Мотор заднего стеклоочистителя(R3)

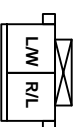

D1-01 Переключатель заднего Стеклоочистителя и омывателя (D)

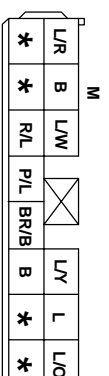

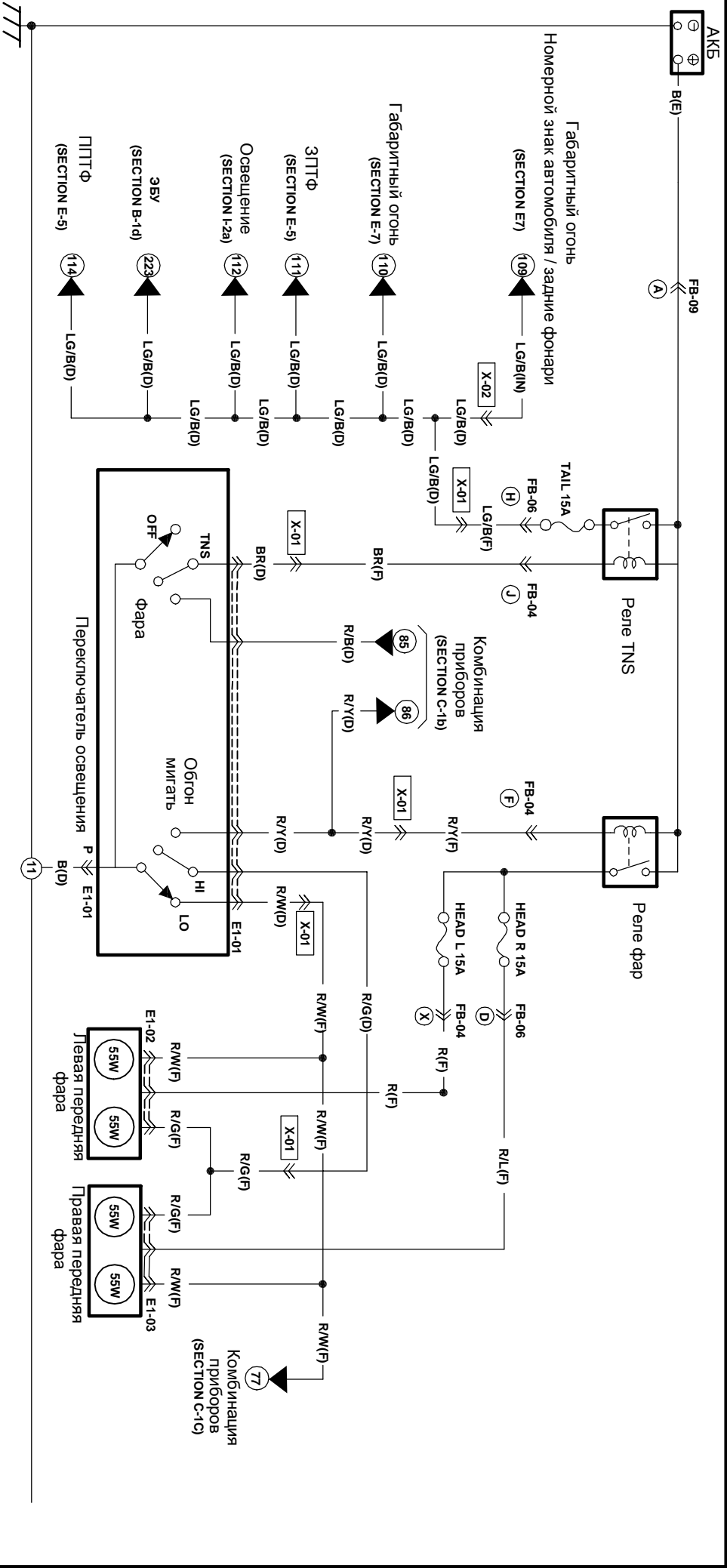

E1-01 Фара переключения (D)

| | | | | | | |
|-----|-----|---|----|-----|-----|-----|
| R/Y | R/G | * | * | W/R | B/Y | W/B |
| R/W | B | * | BR | R/B | * | * |
| P | | | | | | D |

E1-02 Левая передняя фара (F)

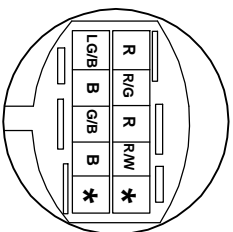

E1-03 Правая передняя фара (F)

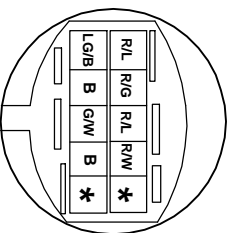

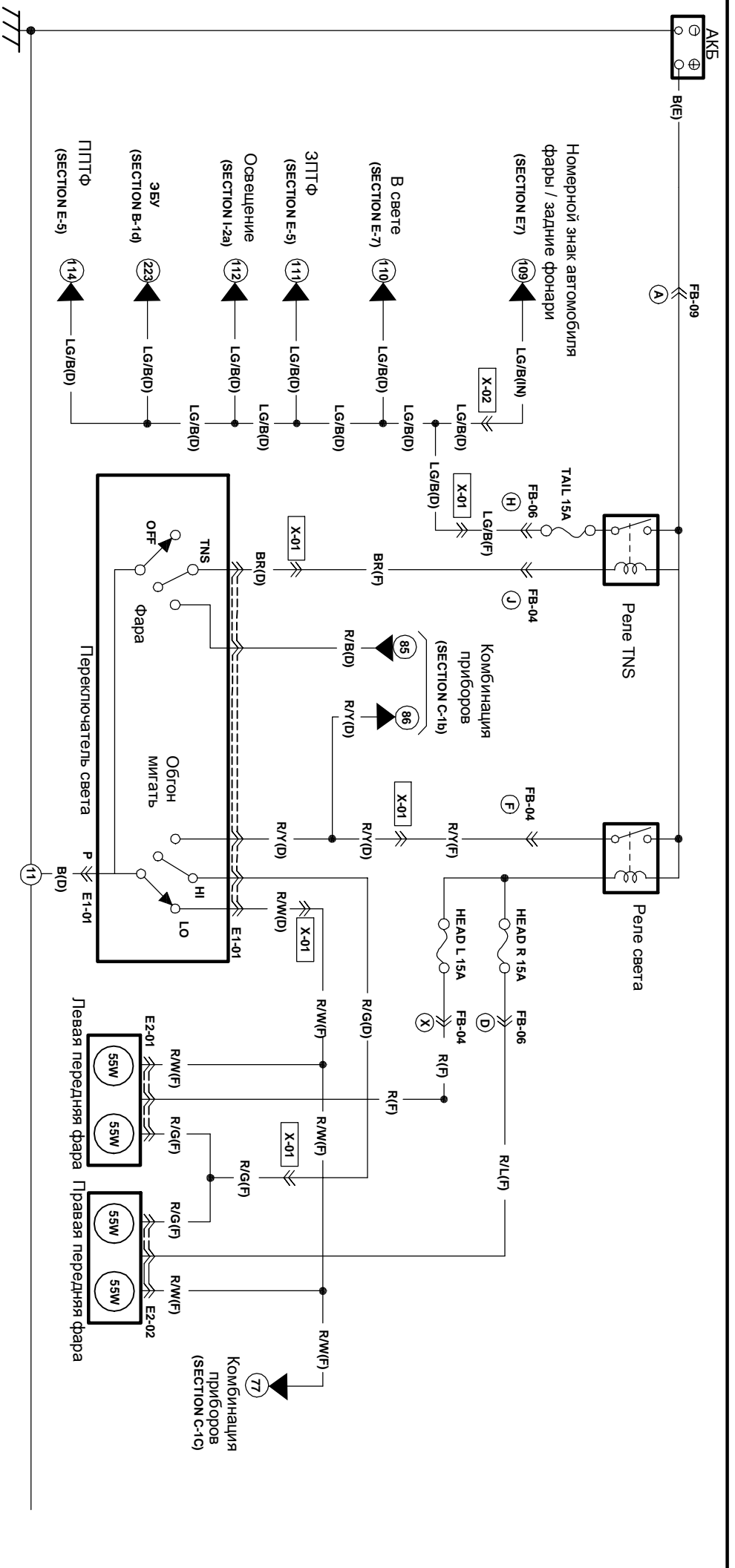

E1-01 Переключатель света

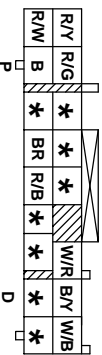

E2-01 Левая передняя фара (F)

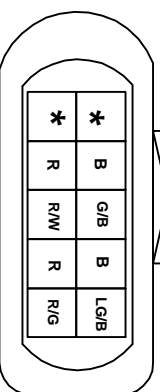

E2-02 Правая передняя фара (F)

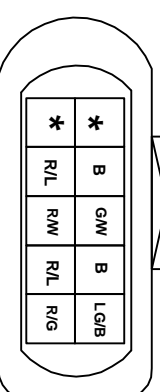

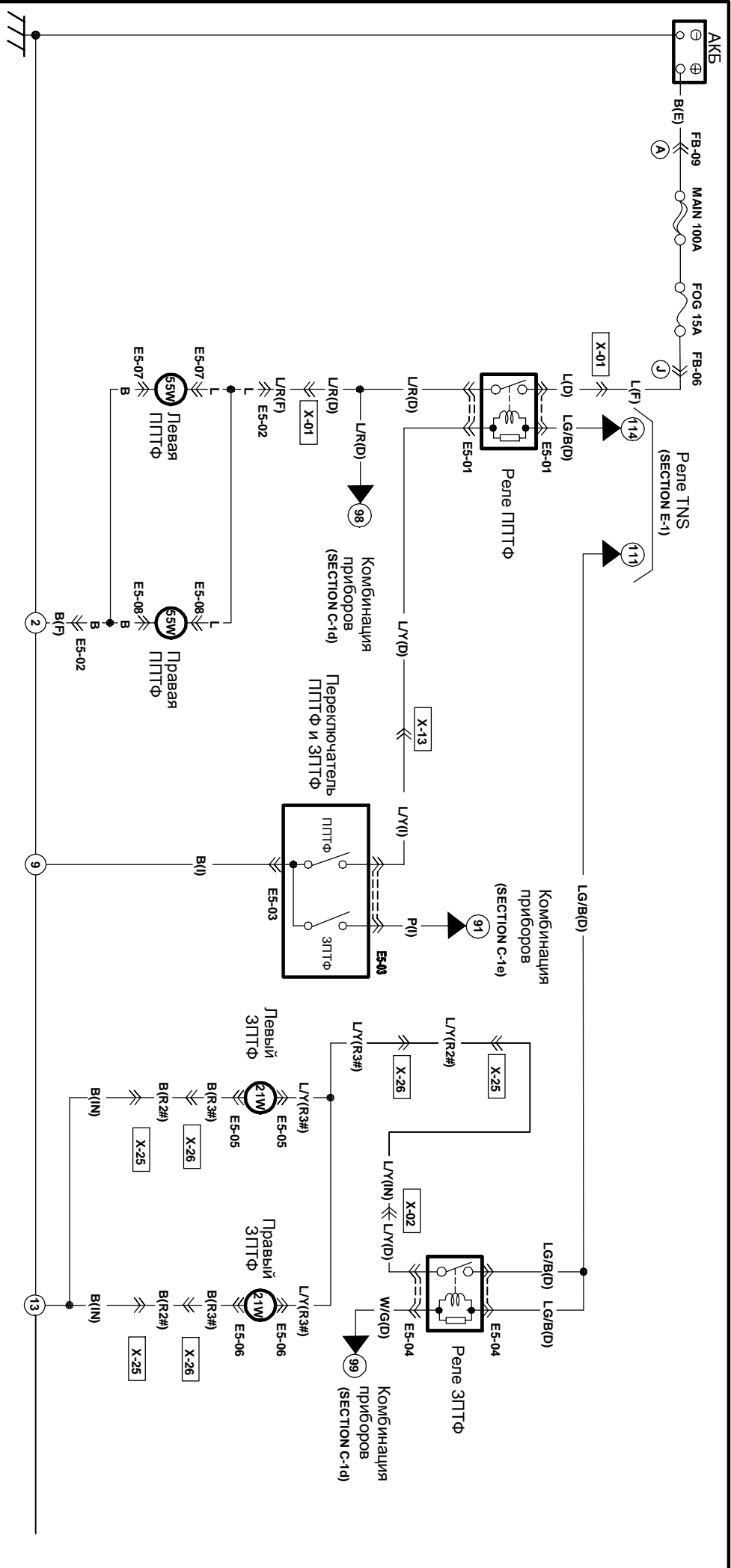

| | | | | | | | |
|-------|--------------|-------|------|-------|------------------------------|-------|--------------|
| E5-01 | Пере ЛПТФ(D) | E5-02 | ЛПТФ | E5-03 | Переключатель ЛПТФ и ЗЛТФ(I) | E5-04 | Пере ЗЛТФ(D) |
|-------|--------------|-------|------|-------|------------------------------|-------|--------------|

| | | | | | | | |
|--|--|--|--|--|--|--|--|
| | | | | | | | |
|--|--|--|--|--|--|--|--|

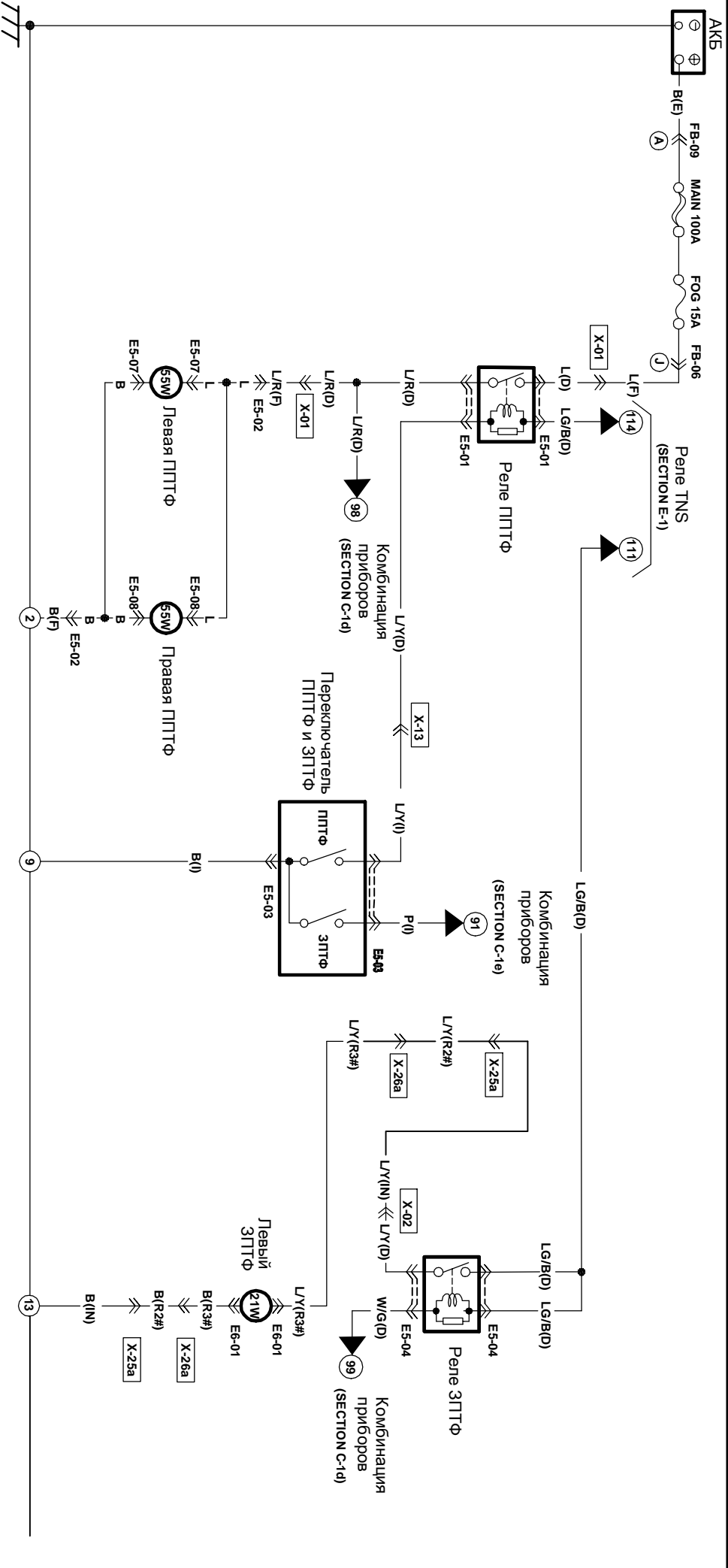

ES-01 Реле ЛПТФ(D)

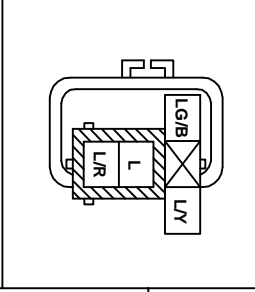

ES-02 ЛПТФ



ES-01 Левый ЗЛТФ(R3#)

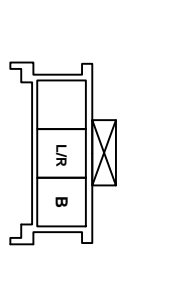

ES-03 Переключатель ЛПТФ и ЗЛТФ(I)

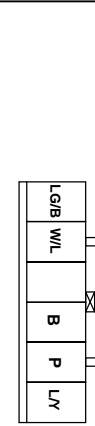

ES-07 Левая ЛПТФ



ES-08 Правая ЛПТФ

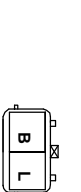

ES-04 Реле ЗЛТФ(D)

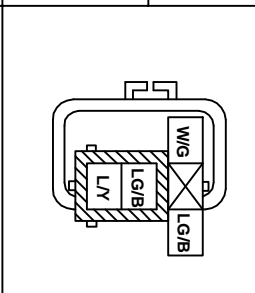

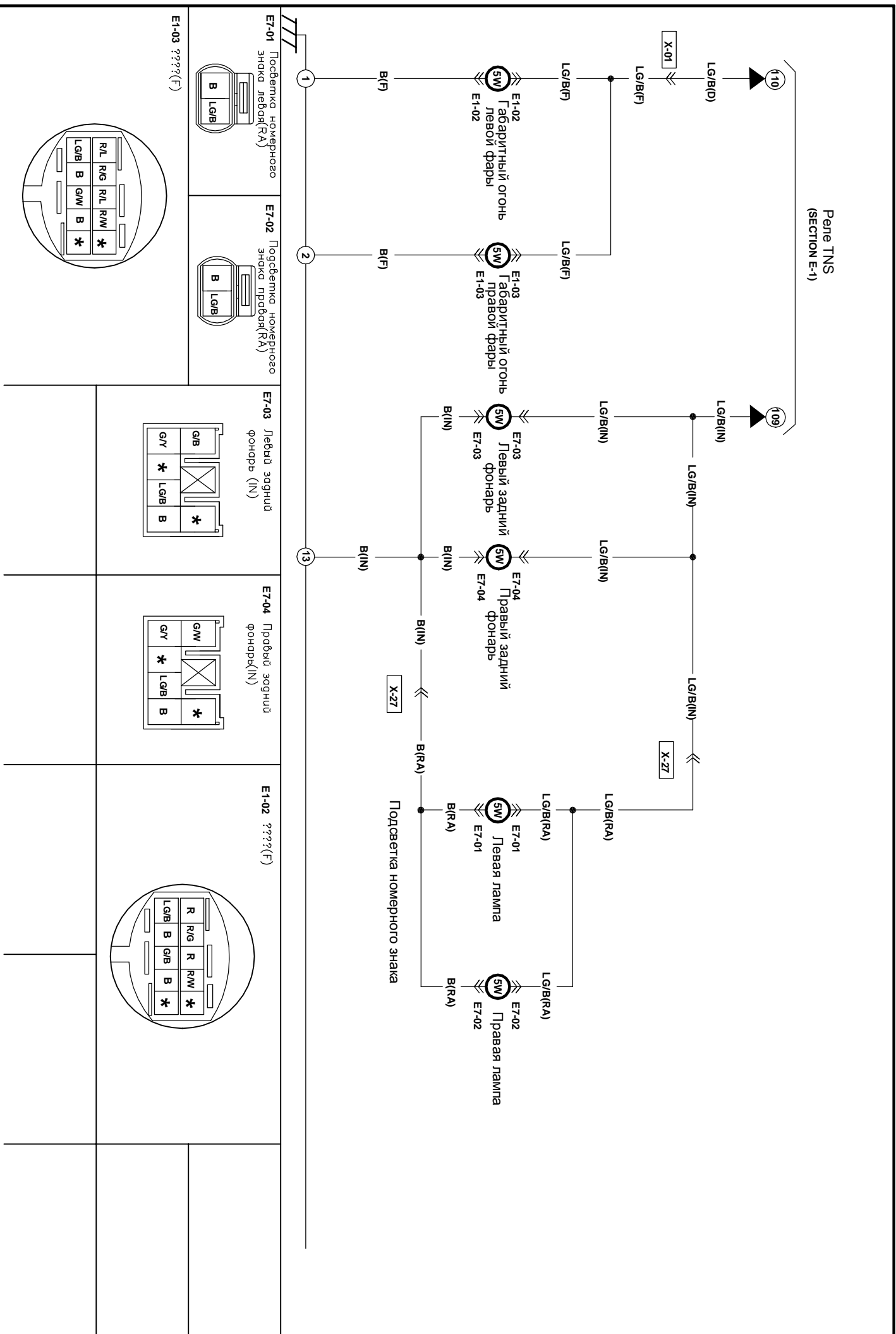

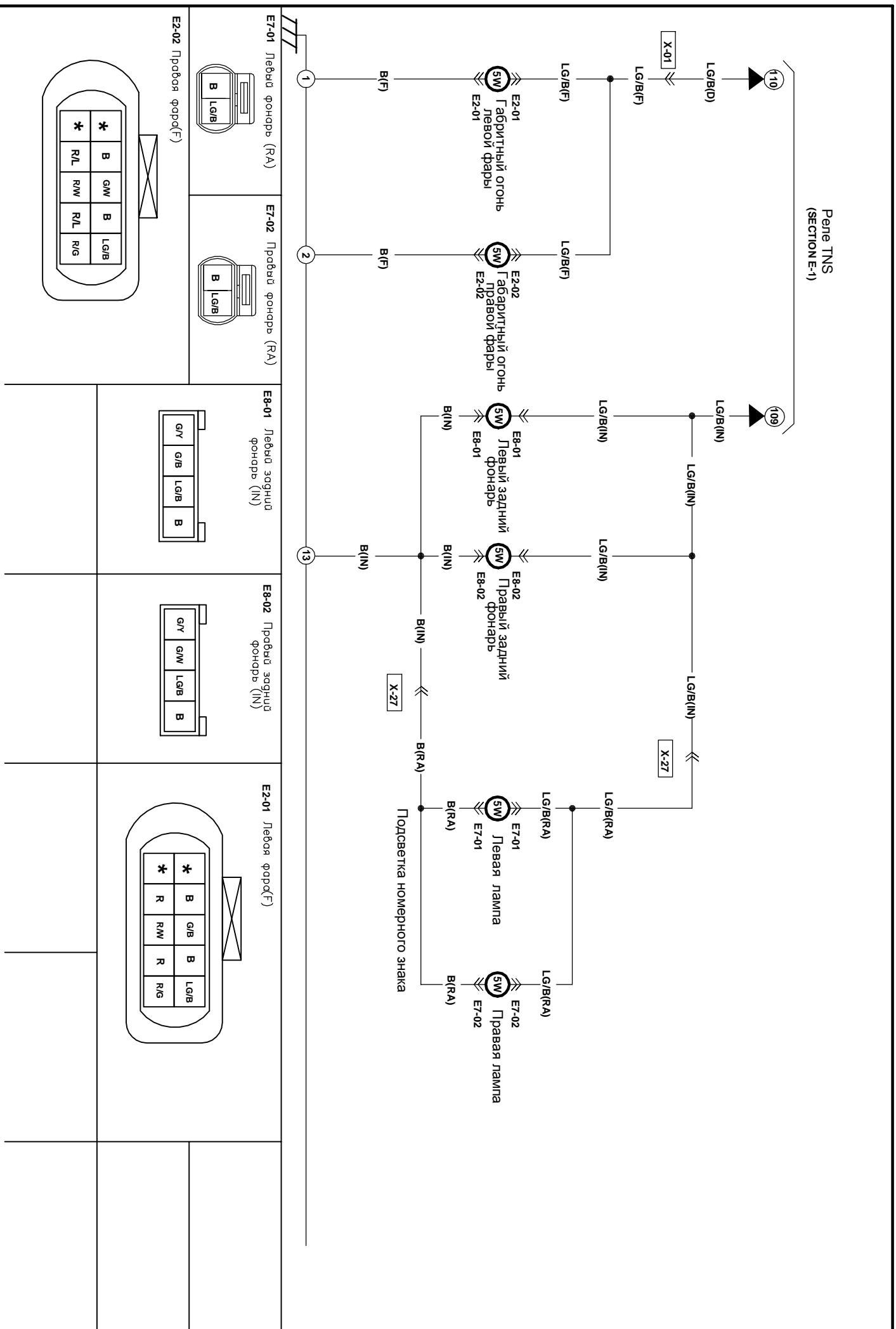

E2-01 Левый фонарь (РА)

E2-02 Правый фонарь (РА)

E8-01 Левый задний фонарь (IN)

E8-02 Правый задний фонарь (IN)

E7-01 Левая лампа

E7-02 Правая лампа

E2-02 Правый фонарь (F)

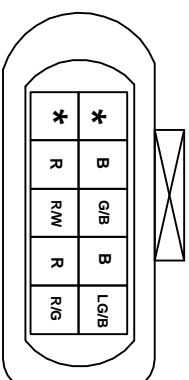

Подсветка номерного знака

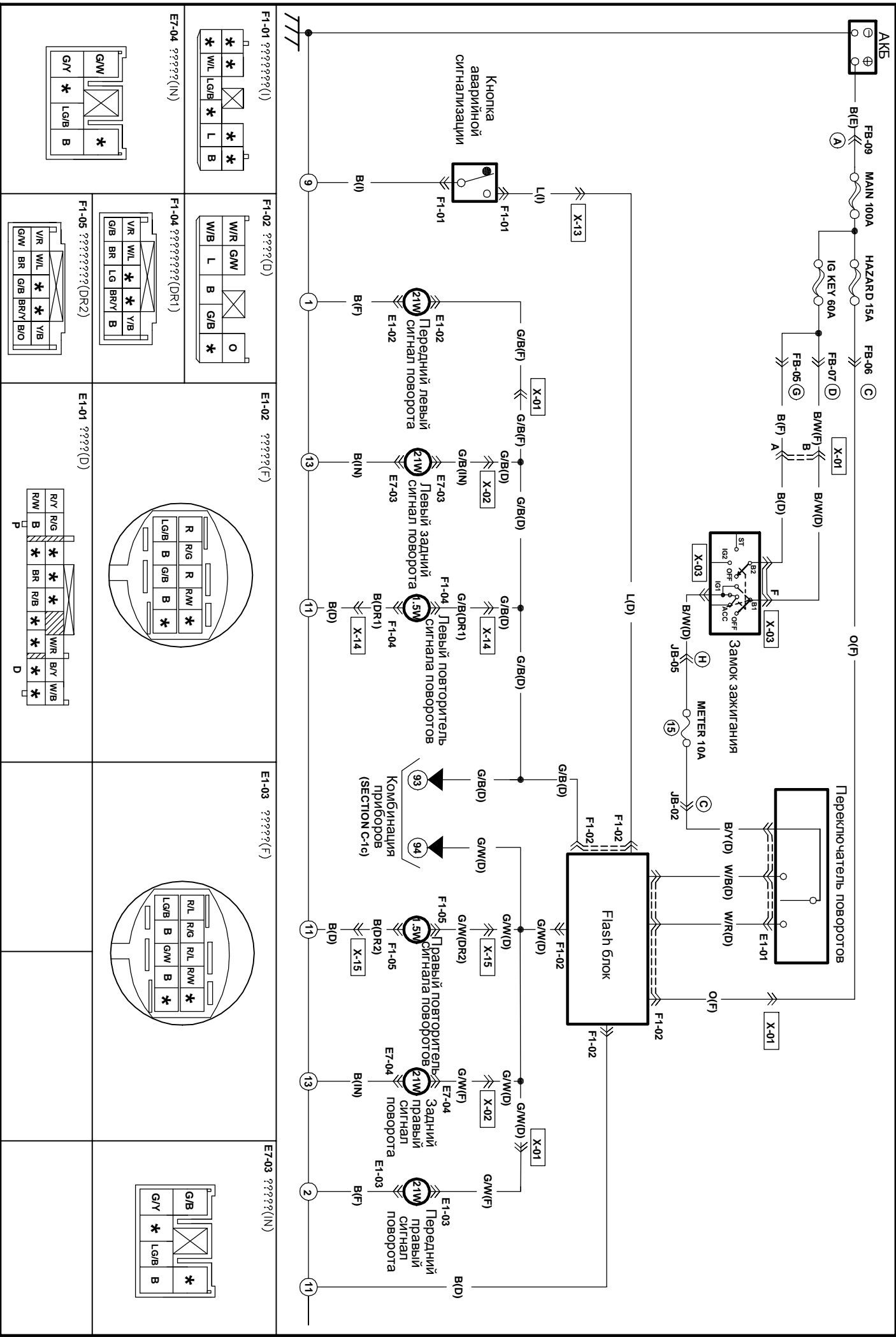

| | | | | | | | | | | | | | | | | | | | | | | | | | | | |
|---|---|-----|-----|-------|-----|-----|---|-----|---|-----|------|-----|-----|----|-----|-----|------|---|-----------------------|-----------------------|--|-----|-----------------------|-----|-------|--|---|
| <p>F1-01 ?????(I)</p> <table border="1"> <tr><td>*</td><td>*</td><td>*</td><td>*</td></tr> <tr><td>W/L</td><td>L</td><td>L</td><td>B</td></tr> </table> | * | * | * | * | W/L | L | L | B | <p>F1-02 ?????(D)</p> <table border="1"> <tr><td>W/R</td><td>G/W</td><td>O</td></tr> <tr><td>L</td><td>B</td><td>G/B</td></tr> <tr><td>*</td><td>*</td><td>*</td></tr> </table> | W/R | G/W | O | L | B | G/B | * | * | * | <p>E1-02 ?????(F)</p> | <p>E1-03 ?????(F)</p> | <p>E7-03 ?????(N)</p> <table border="1"> <tr><td>G/B</td><td>*</td></tr> <tr><td>G/Y</td><td>L/G/B</td></tr> <tr><td></td><td>B</td></tr> </table> | G/B | * | G/Y | L/G/B | | B |
| * | * | * | * | | | | | | | | | | | | | | | | | | | | | | | | |
| W/L | L | L | B | | | | | | | | | | | | | | | | | | | | | | | | |
| W/R | G/W | O | | | | | | | | | | | | | | | | | | | | | | | | | |
| L | B | G/B | | | | | | | | | | | | | | | | | | | | | | | | | |
| * | * | * | | | | | | | | | | | | | | | | | | | | | | | | | |
| G/B | * | | | | | | | | | | | | | | | | | | | | | | | | | | |
| G/Y | L/G/B | | | | | | | | | | | | | | | | | | | | | | | | | | |
| | B | | | | | | | | | | | | | | | | | | | | | | | | | | |
| <p>E7-04 ?????(N)</p> <table border="1"> <tr><td>G/W</td><td>*</td></tr> <tr><td>L</td><td>L/G/B</td></tr> <tr><td></td><td>B</td></tr> </table> | G/W | * | L | L/G/B | | B | <p>F1-04 ?????(DR1)</p> <table border="1"> <tr><td>V/R</td><td>W/L</td><td>*</td><td>*</td><td>V/B</td></tr> <tr><td>G/B</td><td>BR</td><td>L</td><td>G</td><td>BR/Y</td></tr> <tr><td></td><td></td><td></td><td></td><td>B</td></tr> </table> | V/R | W/L | * | * | V/B | G/B | BR | L | G | BR/Y | | | | | B | <p>E1-01 ?????(D)</p> | | | | |
| G/W | * | | | | | | | | | | | | | | | | | | | | | | | | | | |
| L | L/G/B | | | | | | | | | | | | | | | | | | | | | | | | | | |
| | B | | | | | | | | | | | | | | | | | | | | | | | | | | |
| V/R | W/L | * | * | V/B | | | | | | | | | | | | | | | | | | | | | | | |
| G/B | BR | L | G | BR/Y | | | | | | | | | | | | | | | | | | | | | | | |
| | | | | B | | | | | | | | | | | | | | | | | | | | | | | |
| | <p>F1-05 ?????(DR2)</p> <table border="1"> <tr><td>V/R</td><td>W/L</td><td>*</td><td>*</td><td>V/B</td></tr> <tr><td>G/W</td><td>BR</td><td>L</td><td>G</td><td>BR/Y</td></tr> <tr><td></td><td></td><td></td><td></td><td>B/O</td></tr> </table> | V/R | W/L | * | * | V/B | G/W | BR | L | G | BR/Y | | | | | B/O | | | | | | | | | | | |
| V/R | W/L | * | * | V/B | | | | | | | | | | | | | | | | | | | | | | | |
| G/W | BR | L | G | BR/Y | | | | | | | | | | | | | | | | | | | | | | | |
| | | | | B/O | | | | | | | | | | | | | | | | | | | | | | | |

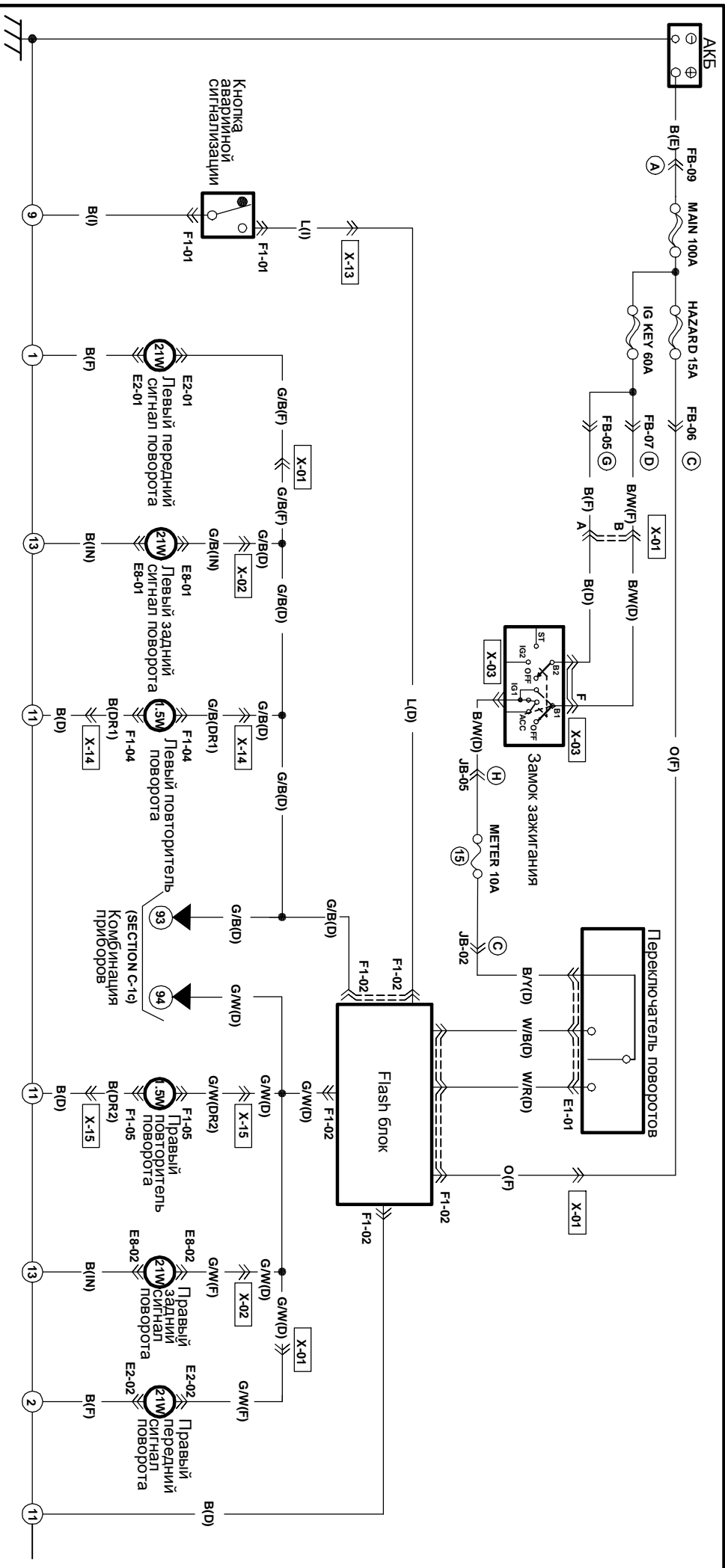

| | | | | |
|--|--|--|---|---|
| <p>F1-01 Кнопка аварийной сигнализации (I)</p> | <p>F1-02 Flash блок (D)</p> | <p>E2-01 Передний левый сигнал поворота (F)</p> | <p>E2-02 Передний правый сигнал поворота (F)</p> | <p>E8-01 Левый задний сигнал поворота (IN)</p> |
| <p>E8-02 Правый задний сигнал поворота (IN)</p> | <p>F1-04 Левый повторитель поворота (DR1)</p> | <p>E1-01 Переключатель поворотов (D)</p> | <p>F1-05 Правый повторитель поворота (DR2)</p> | |

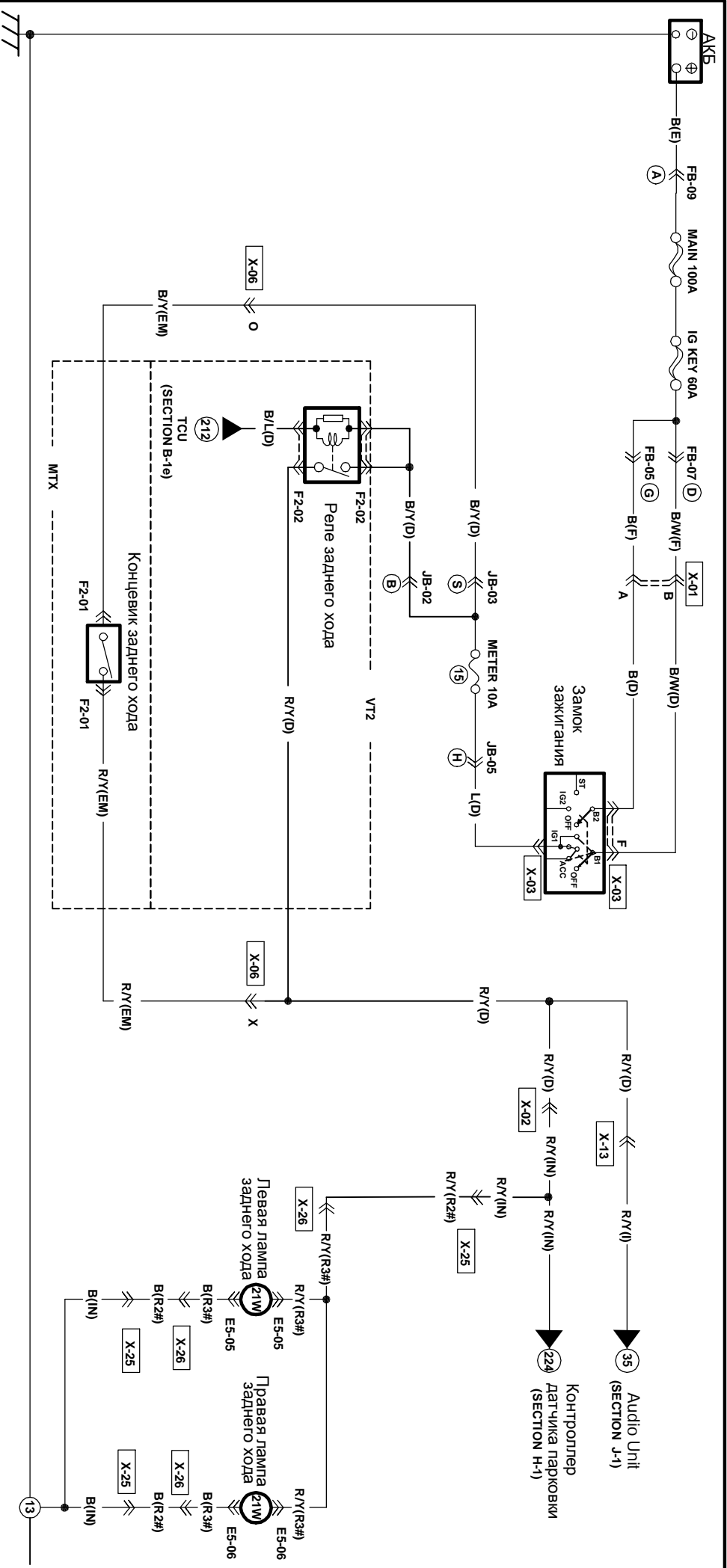

F2-01 Концевик заднего хода (EV)

E5-05 Лампа заднего хода левая (R3#)

E5-06 Лампа заднего хода правая (R3#)

F2-02 Реле заднего хода

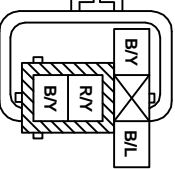
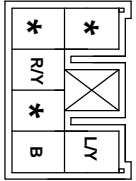
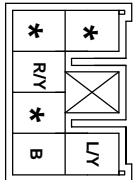

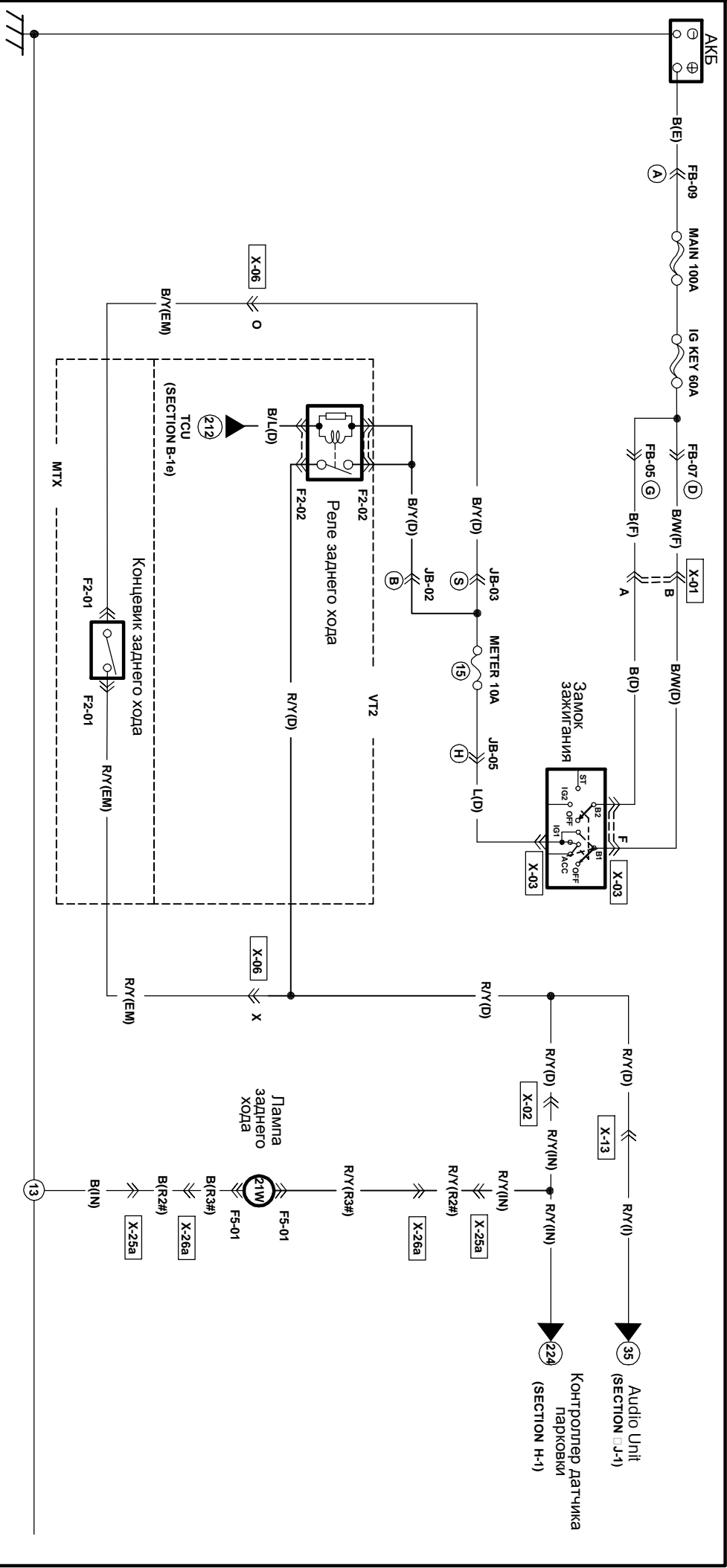

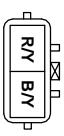
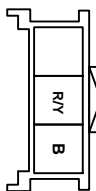
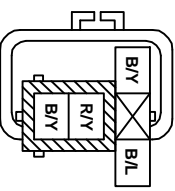

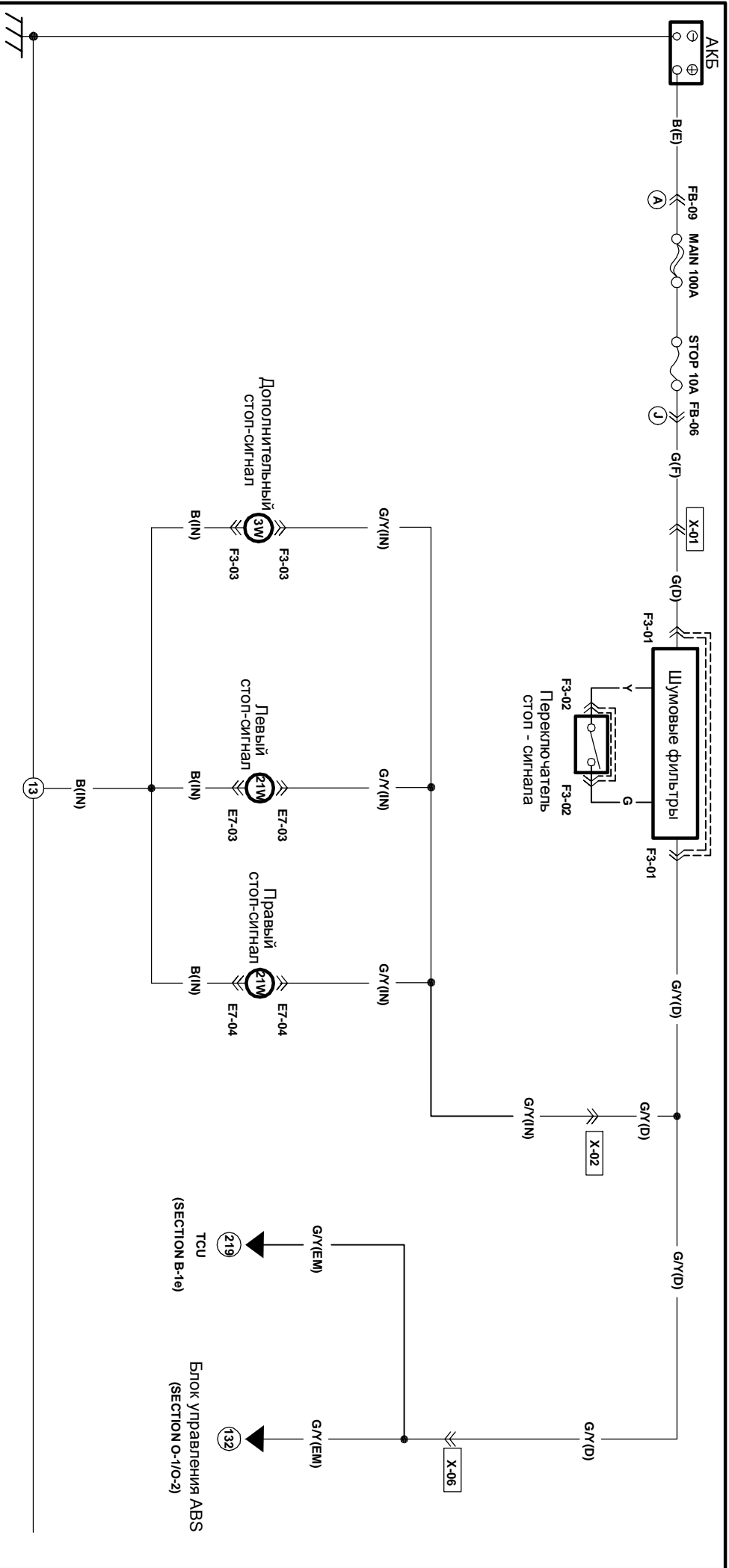

| | | | | | | |
|--|---|---|--|--|--|--|
| <p>F2-01 Концевик заднего хода (EM)</p>  | <p>F5-01 Лампа заднего хода(R3#)</p>  | <p>F2-02 Реле заднего хода</p>  | | | | |
|--|---|---|--|--|--|--|

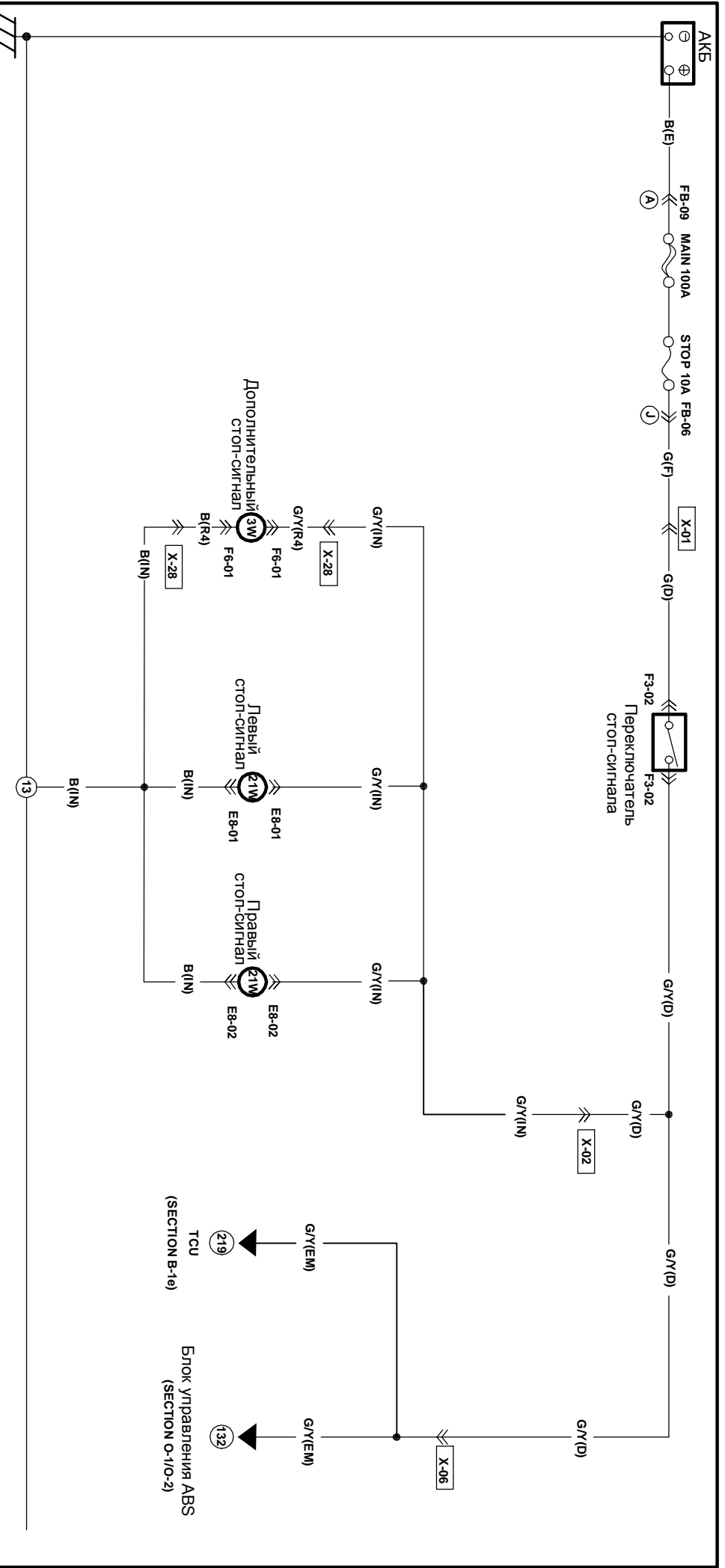

| | | | | | | |
|-----------------|-----------------|-----------------|--|--|--|--|
| F3-01 ?????(D) | F3-02 ????? | F3-03 ?????(IN) | | | | |
| | | | | | | |
| E7-03 ?????(IN) | E7-04 ?????(IN) | | | | | |
| | | | | | | |

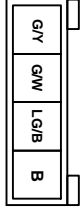

| | | | | | | |
|--|---|---|--|--|--|--|
| <p>F3-01 ?????(D)</p>  | <p>F3-02 Переключатель стоп-сигналов</p>  | <p>F6-01 Дополнительный стоп-сигнал (R4)</p>  | | | | |
| <p>E8-01 Левый стоп-сигнал (IN)</p>  | <p>E8-02 Правый стоп-сигнал (IN)</p>  | | | | | |

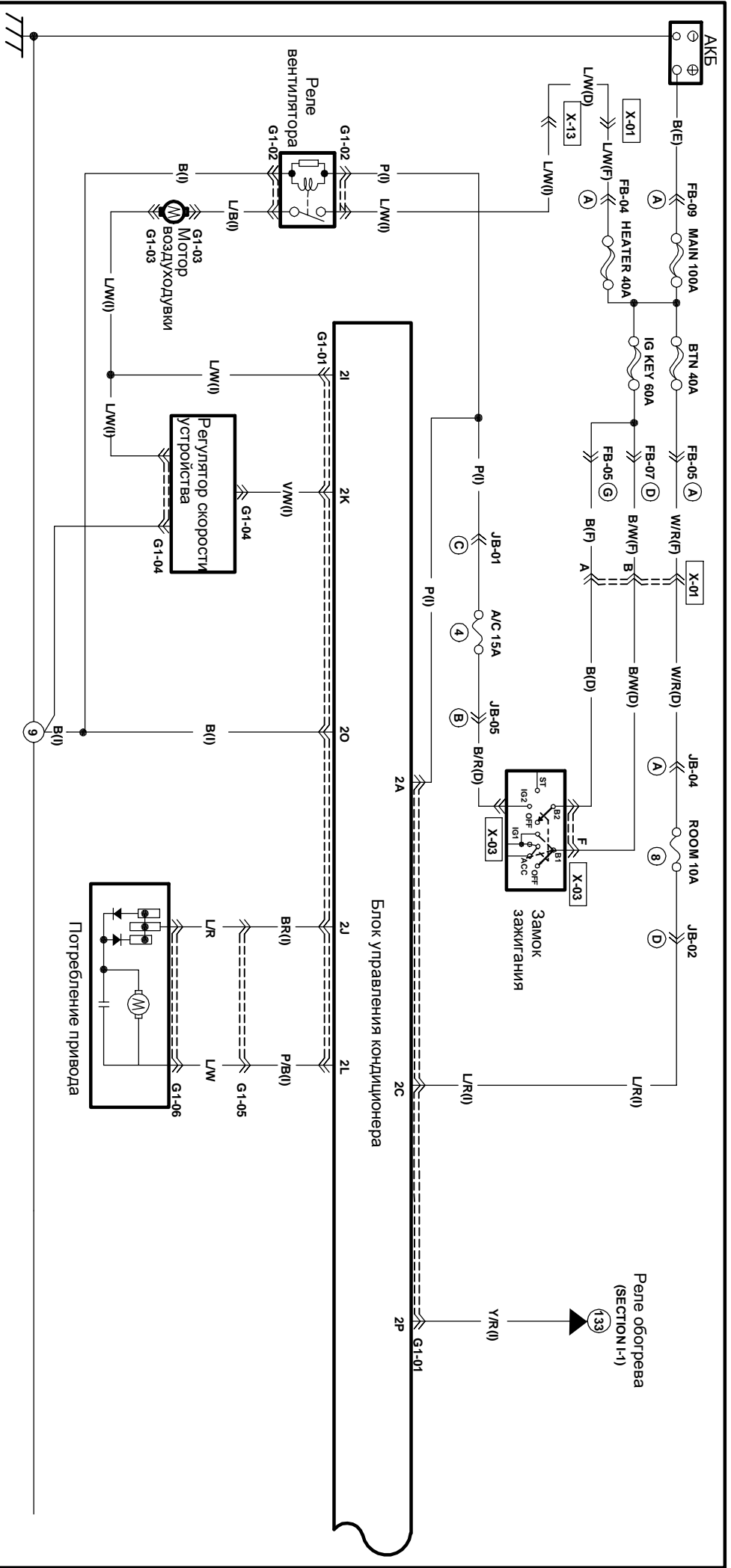

G1-01 ?????(I) G1-02 ?????(I) G1-03 ?????(I) G1-04 ?????(I) G1-05 ?????(I) G1-06 ?????(I)

| | | | | | |
|-----|------|-------|-----|----|-------|
| 1K | 1I | 1G | 1E | 1C | 1A |
| V/V | BR/V | L/G/R | P/B | * | O |
| L/Y | W/L | Y/B | Y/G | * | G/Y/R |
| 1L | 1J | 1H | 1F | 1D | 1B |

| | | | | | | | |
|-----|------|-----|-----|-------|-----|-----|-----|
| 20 | 2M | 2K | 2I | 2G | 2E | 2C | 2A |
| B | * | V/W | L/W | L/G/B | W/L | L/R | P |
| Y/R | BR/B | P/B | BR | B/W | L | Y | G/Y |
| 2P | 2N | 2L | 2J | 2H | 2F | 2D | 2B |

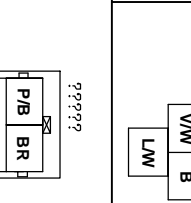
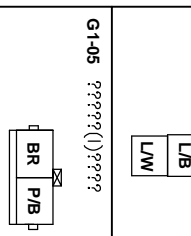
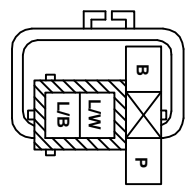

| | | | | | |
|-----|---|---|---|---|-----|
| L/R | * | * | * | * | L/W |
|-----|---|---|---|---|-----|

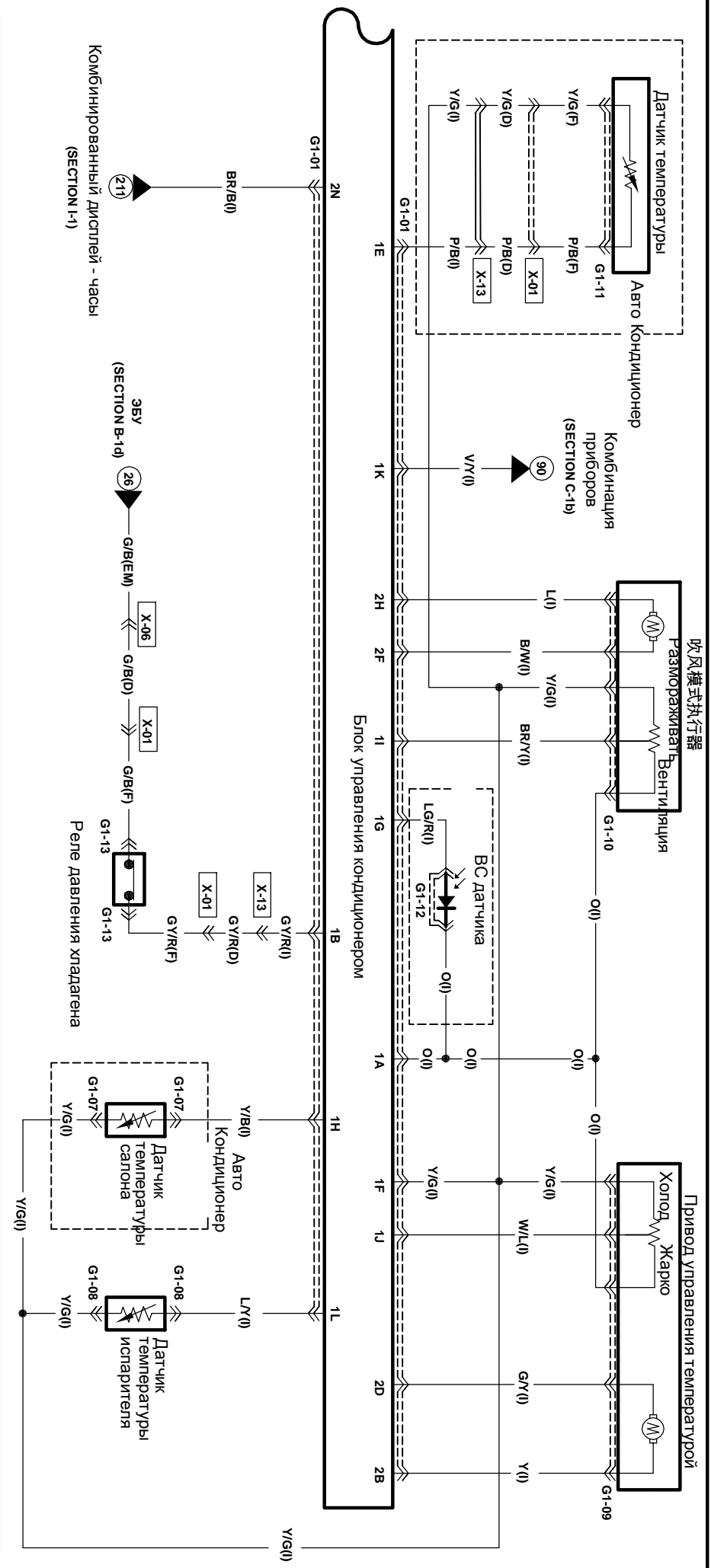

ТТТ

G1-01 ?????(I)

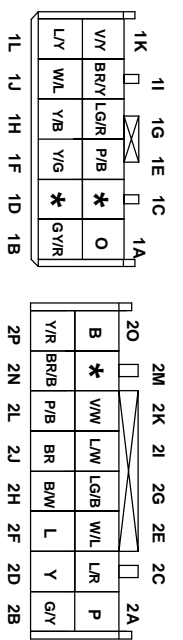

G1-07 ???????(I)

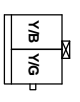

G1-08 ???????(I)

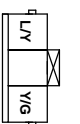

G1-09 ???????(I)

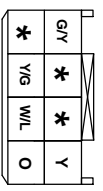

G1-10 ???????(I)

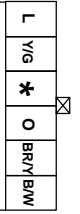

G1-11 ???????(F)

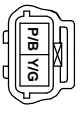



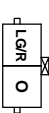

G1-12 ?????(I)

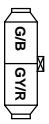

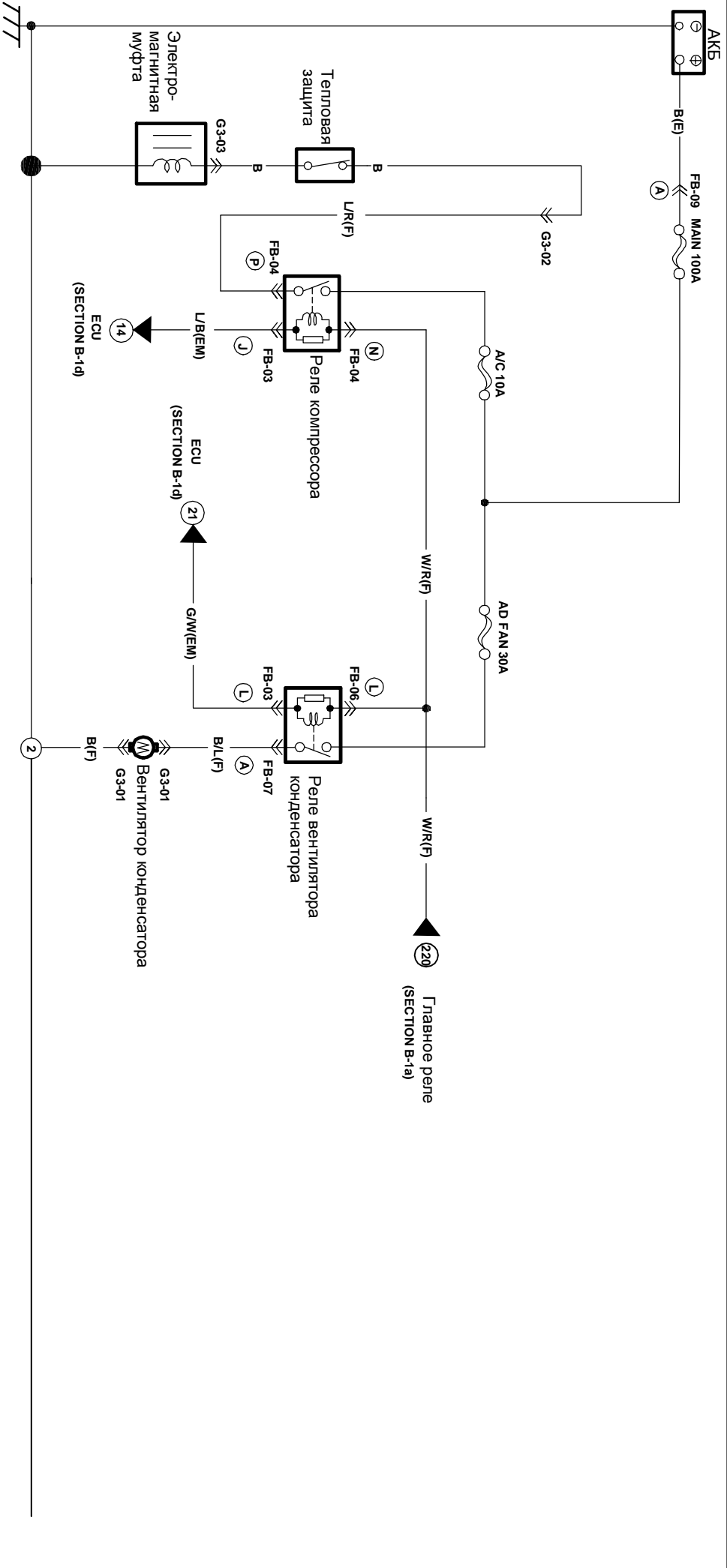
G1-13 ???????(F)

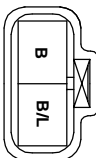



| | | | | | | |
|---|---|--|--|--|--|--|
| <p>G3-01</p> <p>????(F)</p>  | <p>G3-02</p> <p>????(F)</p>  | <p>G3-02</p> <p>????</p>  | <p>G3-03</p> <p>??????????</p>   | | | |
|---|---|--|--|--|--|--|

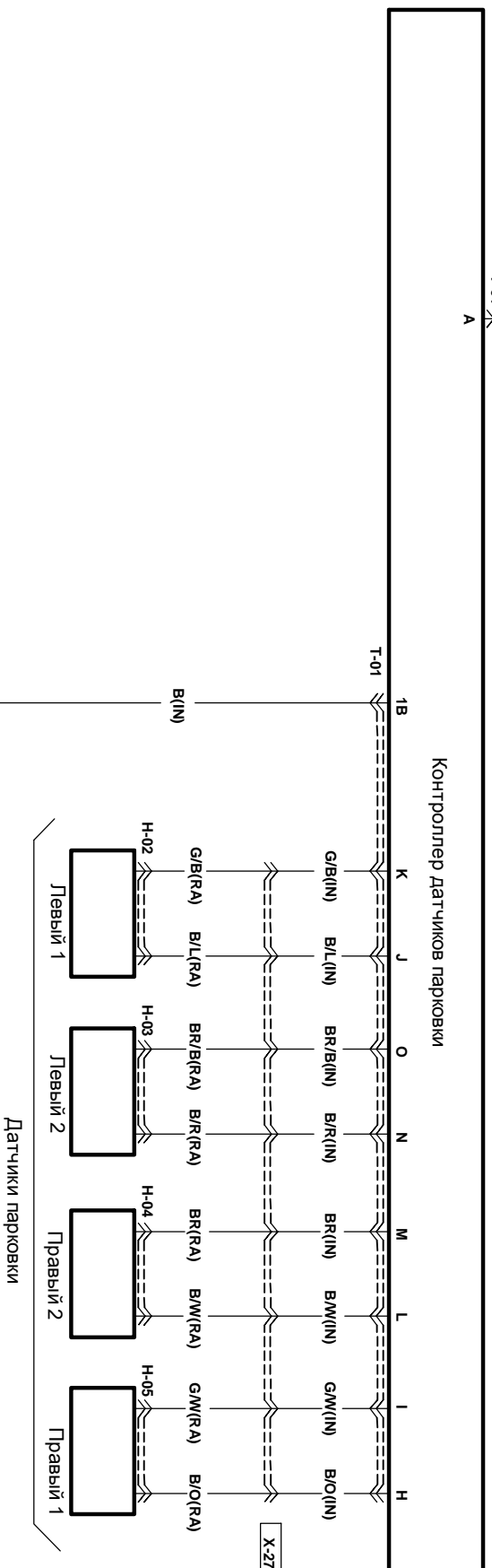
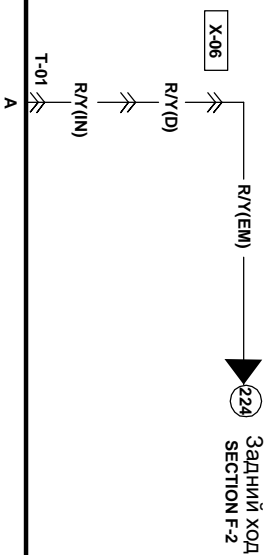

| | | | | | | | | | | | | | | | | | | | | | | | | | | | | | | | | | | | | | | | | | | | | | | | | | |
|---|------|-----|-----|-----|---|---|---|-----|---|------|----|-----|-----|---|---|---|---|-----|---|-----|-----|-----|-----|---|---|---|---|---|---|---|---|---|---|---|---|--|---|-----|-----|--|-----|------|--|-----|----|---|-----|-----|--|
| <p>H-01 ??????(IN)</p> <table border="1" style="margin-left: auto; margin-right: auto;"> <tr> <td></td><td>O</td><td>M</td><td>K</td><td>I</td><td>G</td><td>E</td><td>C</td><td>A</td> </tr> <tr> <td>BR/B</td><td>BR</td><td>G/B</td><td>G/W</td><td>*</td><td>*</td><td>*</td><td>*</td><td>R/Y</td> </tr> <tr> <td>B</td><td>B/R</td><td>B/W</td><td>B/L</td><td>B/O</td><td>*</td><td>*</td><td>*</td><td>*</td> </tr> <tr> <td>P</td><td>N</td><td>L</td><td>J</td><td>H</td><td>F</td><td>D</td><td>B</td><td></td> </tr> </table> | | O | M | K | I | G | E | C | A | BR/B | BR | G/B | G/W | * | * | * | * | R/Y | B | B/R | B/W | B/L | B/O | * | * | * | * | P | N | L | J | H | F | D | B | | <p>H-02 ??????(RA)</p> <table border="1" style="margin-left: auto; margin-right: auto;"> <tr> <td>B/L</td><td>G/B</td> </tr> </table> | B/L | G/B | <p>H-03 ??????(RA)</p> <table border="1" style="margin-left: auto; margin-right: auto;"> <tr> <td>B/R</td><td>BR/B</td> </tr> </table> | B/R | BR/B | <p>H-04 ??????(RA)</p> <table border="1" style="margin-left: auto; margin-right: auto;"> <tr> <td>B/W</td><td>BR</td> </tr> </table> | B/W | BR | <p>H-05 ??????(RA)</p> <table border="1" style="margin-left: auto; margin-right: auto;"> <tr> <td>B/O</td><td>G/W</td> </tr> </table> | B/O | G/W | |
| | O | M | K | I | G | E | C | A | | | | | | | | | | | | | | | | | | | | | | | | | | | | | | | | | | | | | | | | | |
| BR/B | BR | G/B | G/W | * | * | * | * | R/Y | | | | | | | | | | | | | | | | | | | | | | | | | | | | | | | | | | | | | | | | | |
| B | B/R | B/W | B/L | B/O | * | * | * | * | | | | | | | | | | | | | | | | | | | | | | | | | | | | | | | | | | | | | | | | | |
| P | N | L | J | H | F | D | B | | | | | | | | | | | | | | | | | | | | | | | | | | | | | | | | | | | | | | | | | | |
| B/L | G/B | | | | | | | | | | | | | | | | | | | | | | | | | | | | | | | | | | | | | | | | | | | | | | | | |
| B/R | BR/B | | | | | | | | | | | | | | | | | | | | | | | | | | | | | | | | | | | | | | | | | | | | | | | | |
| B/W | BR | | | | | | | | | | | | | | | | | | | | | | | | | | | | | | | | | | | | | | | | | | | | | | | | |
| B/O | G/W | | | | | | | | | | | | | | | | | | | | | | | | | | | | | | | | | | | | | | | | | | | | | | | | |

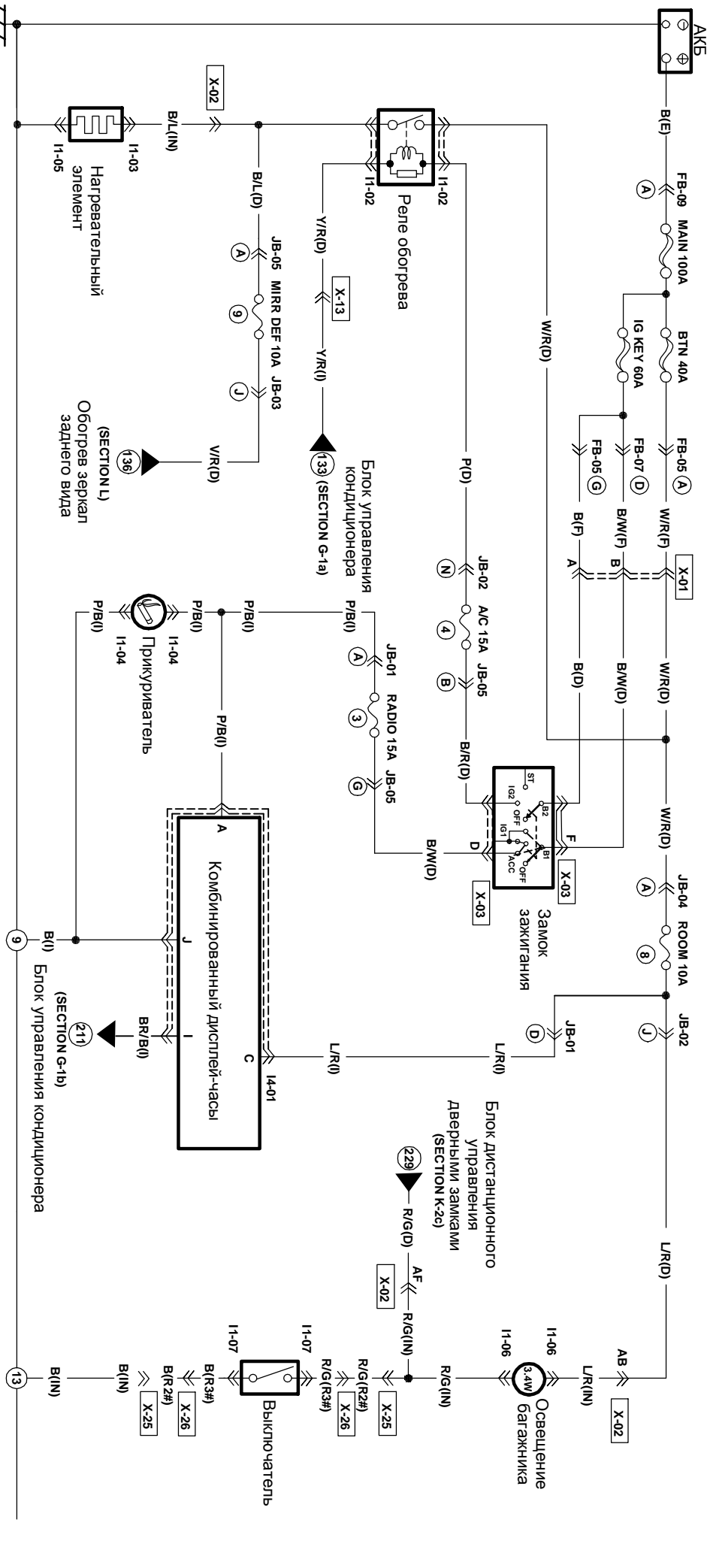

I1-01 ???????(I) I1-02 ???????(D) I1-03 ?????(IN) I1-04 ?????(I) I1-05 ?????(N) I1-06 ?????(IN)

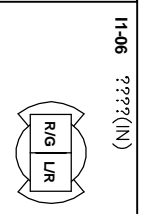
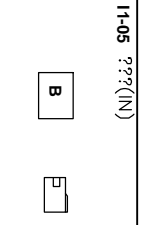
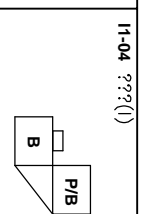
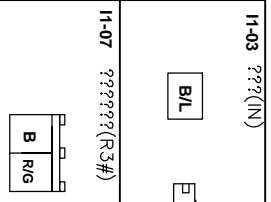
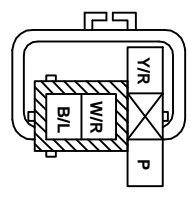
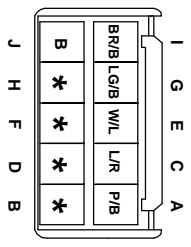

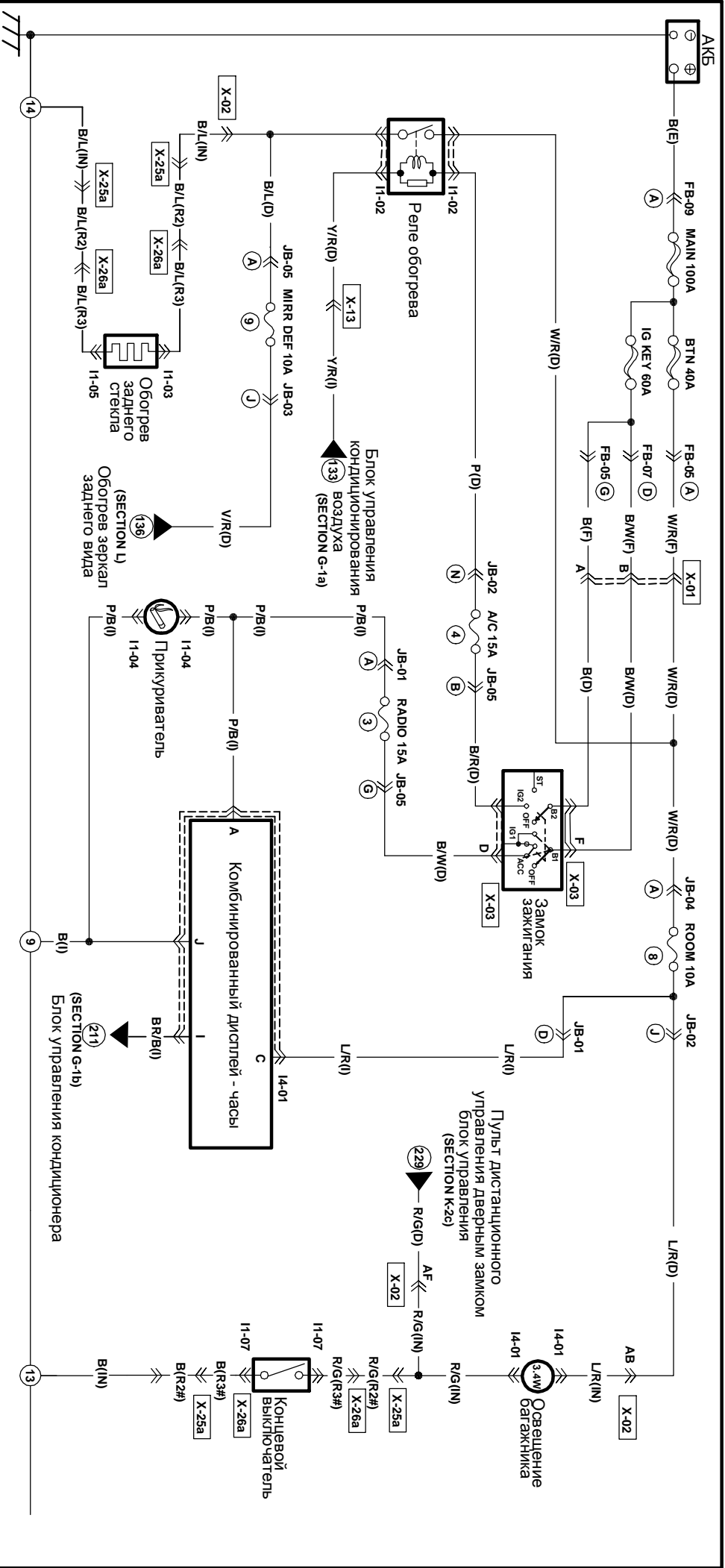

11-01 ???????(I) 11-02 ???????(D) 11-03 ???(R3) 11-04 ???(I) 11-05 ???(R3) 14-01 ?????(IN)

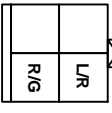
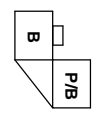
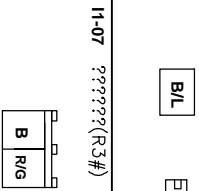
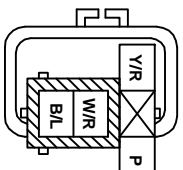
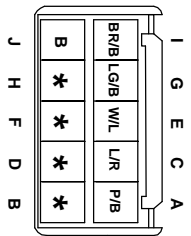

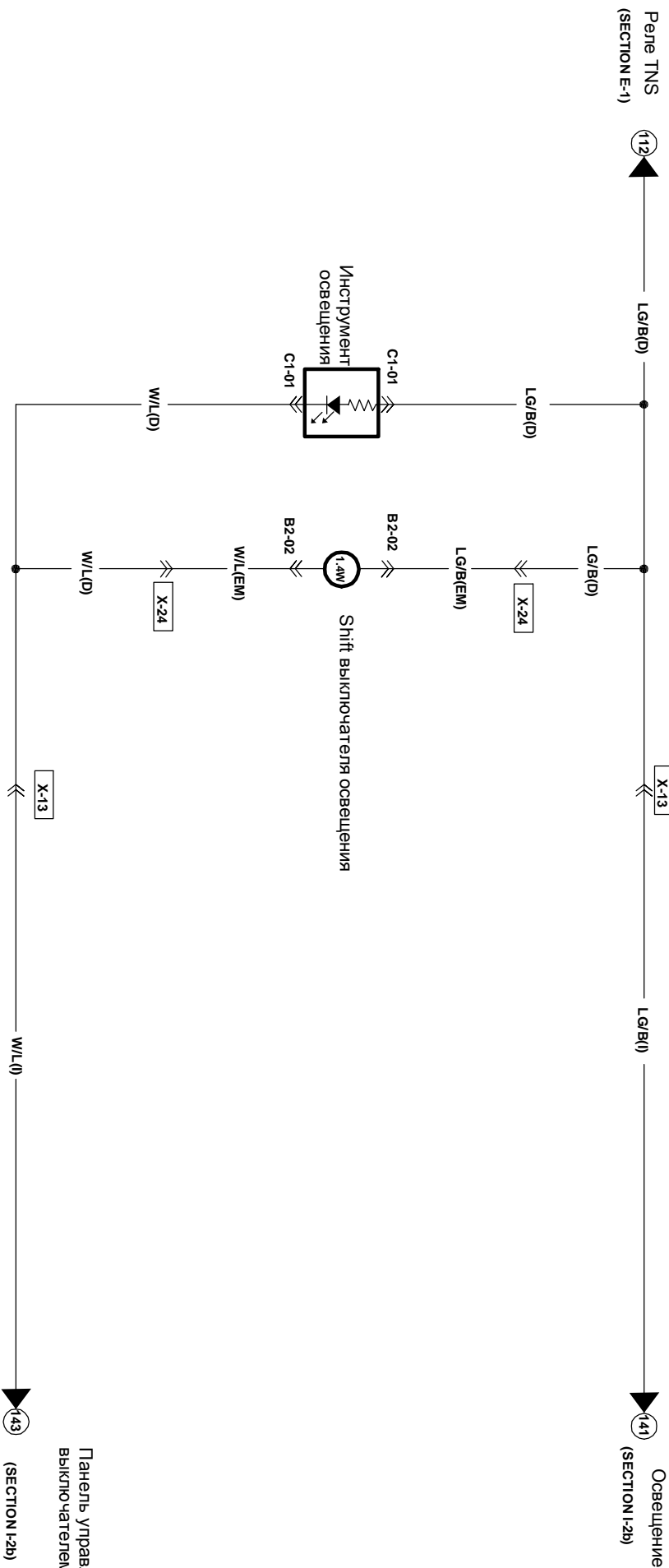

C1-01 ????(D)

B2-02 ???????

| | | | | | | | | |
|------|-----|-----|------|-----|------|------|-----|-----|
| 1Q | 1O | 1M | 1K | 1I | 1G | 1E | 1C | 1A |
| BR | L/R | W/L | Y/B | B/L | BR/B | LG/B | G/B | B/O |
| BR/R | L | L/O | LG/R | B/Y | Y/R | R/W | B | GW |
| 1R | 1P | 1N | 1L | 1J | 1H | 1F | 1D | 1B |

| | |
|------|------|
| LG/B | LG |
| W/L | B/O |
| | BR/Y |
| | BR |

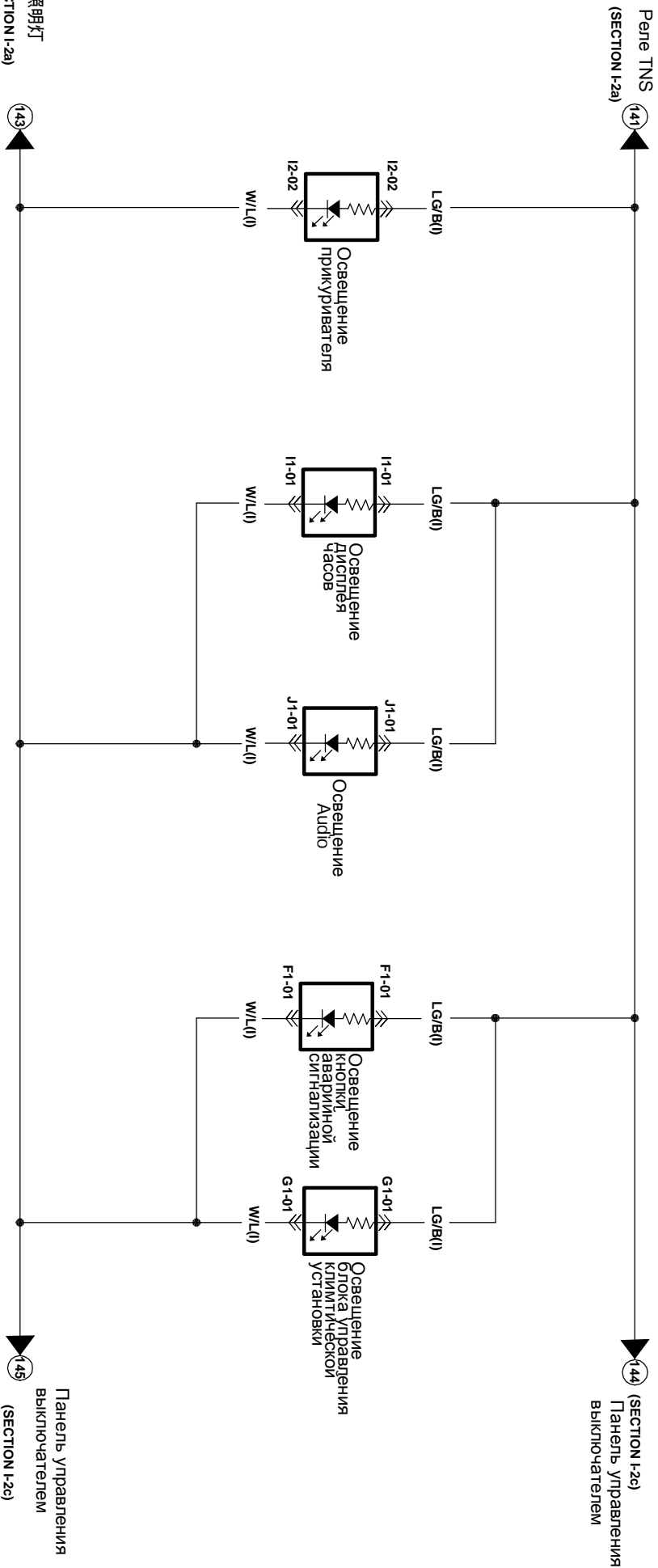

照明灯 (SECTION I-2a)

12-02 ?????(1)

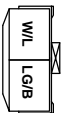

I1-01 ?????????(1)

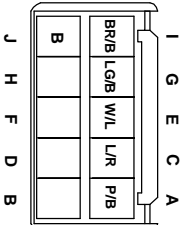

J1-01 ?????????(1)

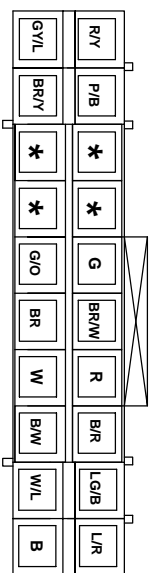

F1-01 ?????????(1)

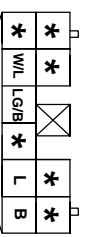

G1-01 ?????????(1)

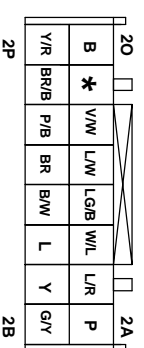

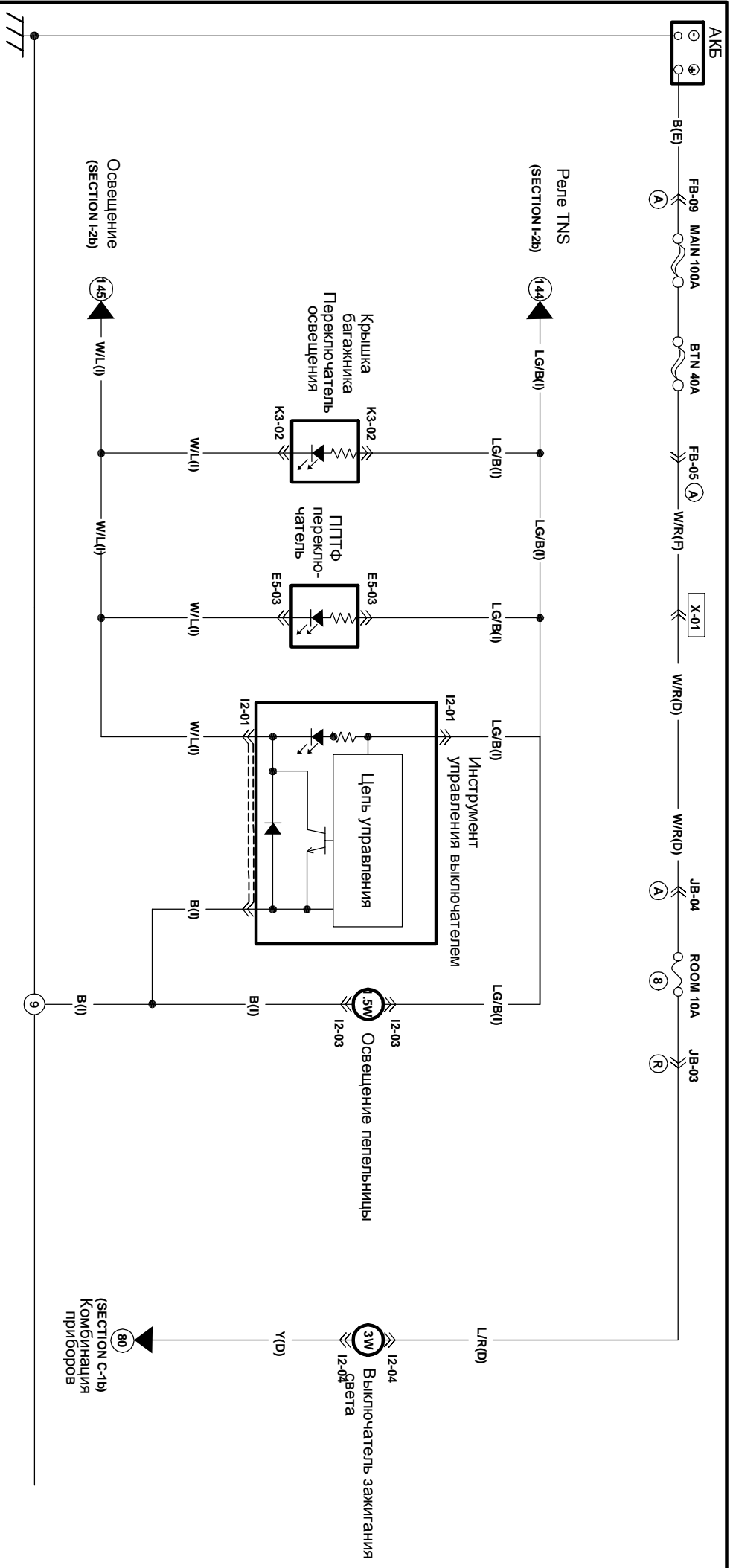

| | | | | | | | | | |
|-------|-------------|-------|----------|-------|-------------|-------|-------------|-------|-------------|
| 12-01 | ????????(I) | 12-03 | ?????(I) | 12-04 | ????????(I) | K3-02 | ????????(I) | E5-03 | ????????(I) |
| | | | | | | | | | |

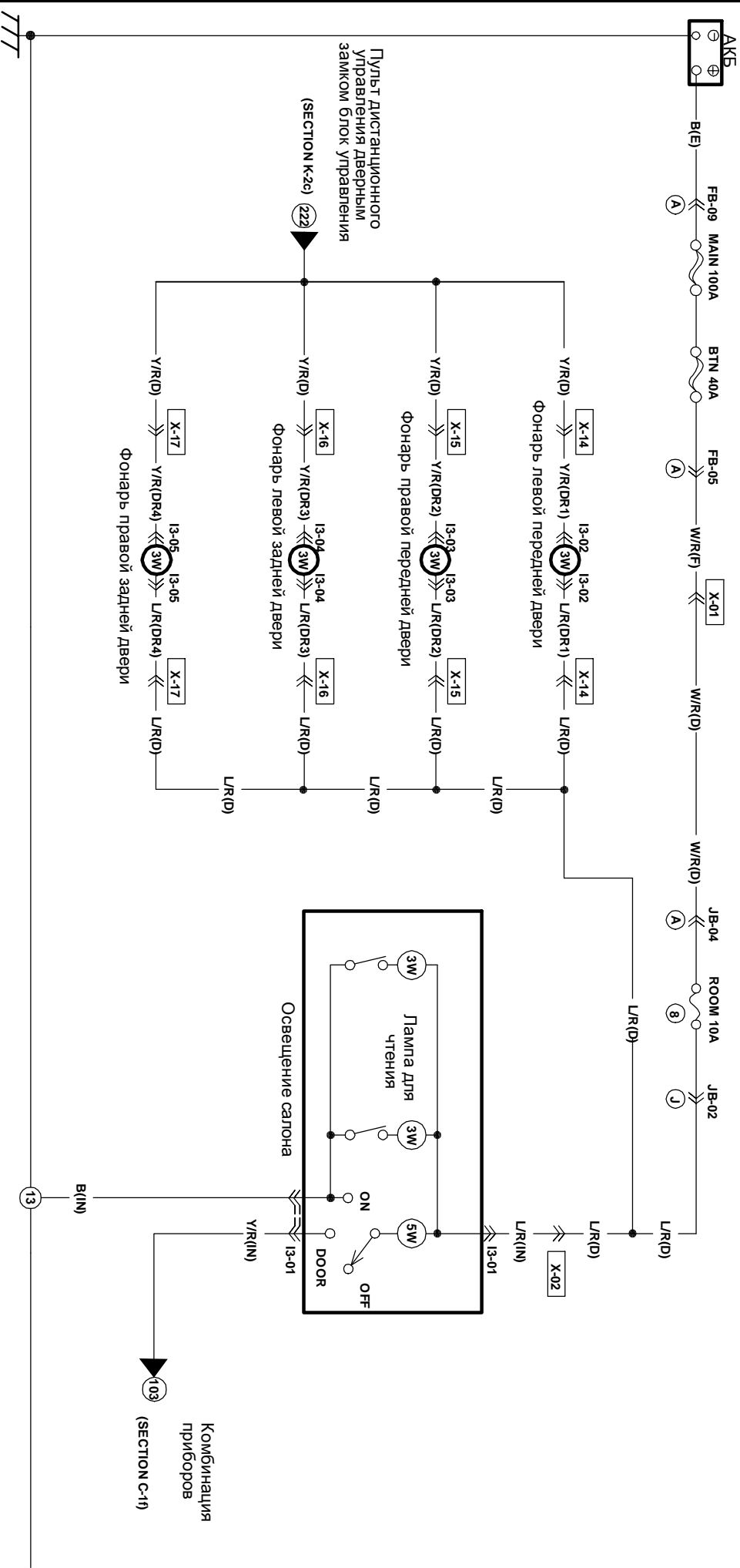

13-01 ???????(IN) 13-02 ???????(DR1) 13-03 ???????(DR2) 13-04 ???????(DR3) 13-05 ???????(DR4)

| | |
|---|-----|
| P | L/R |
| B | Y/R |



| | | | | | | | |
|--|--|--|--|--|--|--|--|
| | | | | | | | |
| | | | | | | | |
| | | | | | | | |

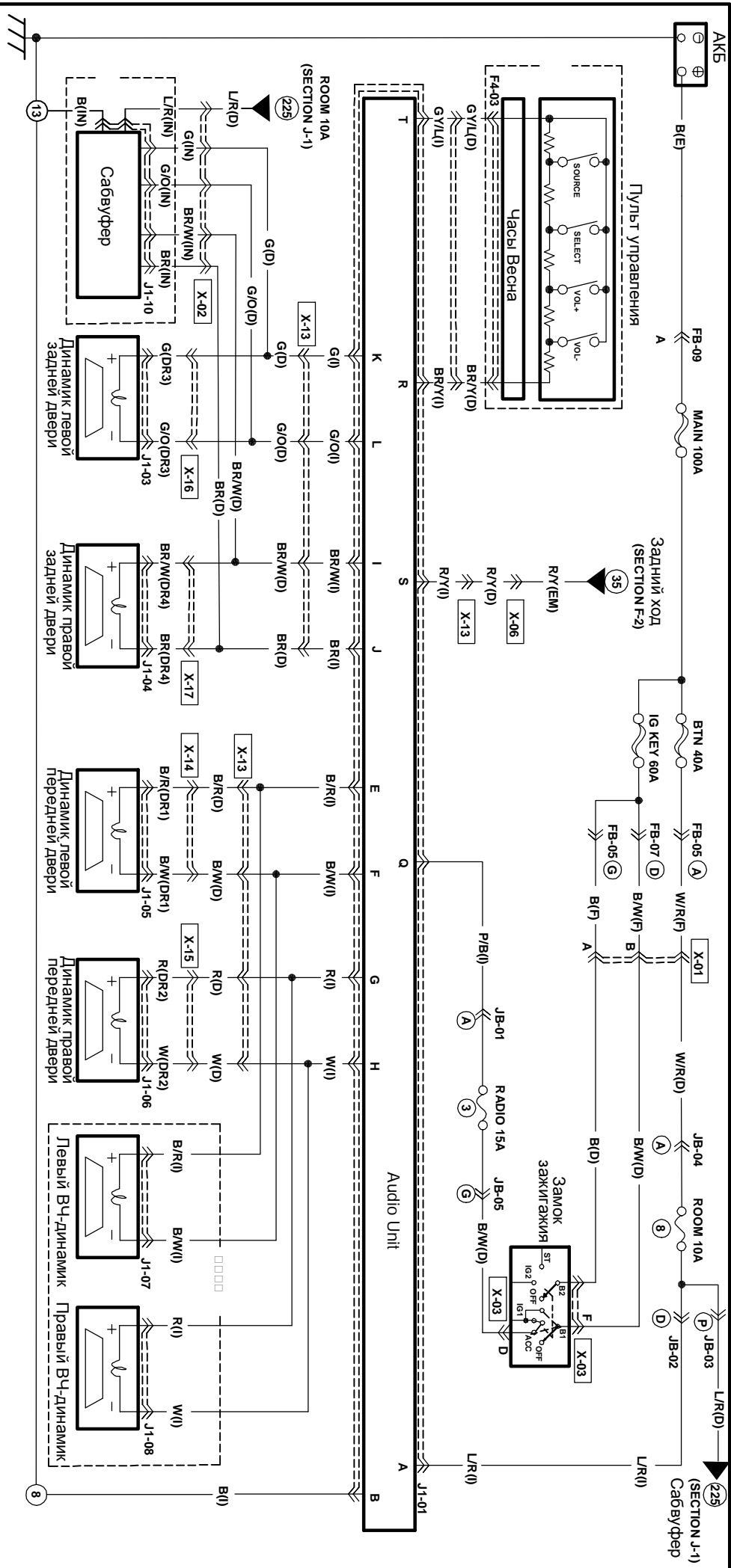

J1-01 ?????(I) J1-03 ?????(DR3) J1-04 ?????(DR4) J1-05 ?????(DR1) J1-06 ?????(DR2) J1-07 ?????(I)

| | | | | | |
|--|----------------------------------|---|---|--|--|
| <p>S Q O M K I G E C A</p> <p>R/Y P/B * * G BR/W R BR BR/LGB L/R</p> <p>T R P N L J H F D B</p> <p>G/YL B/R/V * * G/O BR W B/W W/L B</p> | <p>J1-08 ?????(I)</p> <p>R W</p> | <p>J1-10 ?????(N)</p> <p>L/R B G/L</p> <p>G B/O * BR BR/W</p> | <p>F4-03 ?????(D)</p> <p>B/R * G/YL B/R/V</p> | | |
|--|----------------------------------|---|---|--|--|

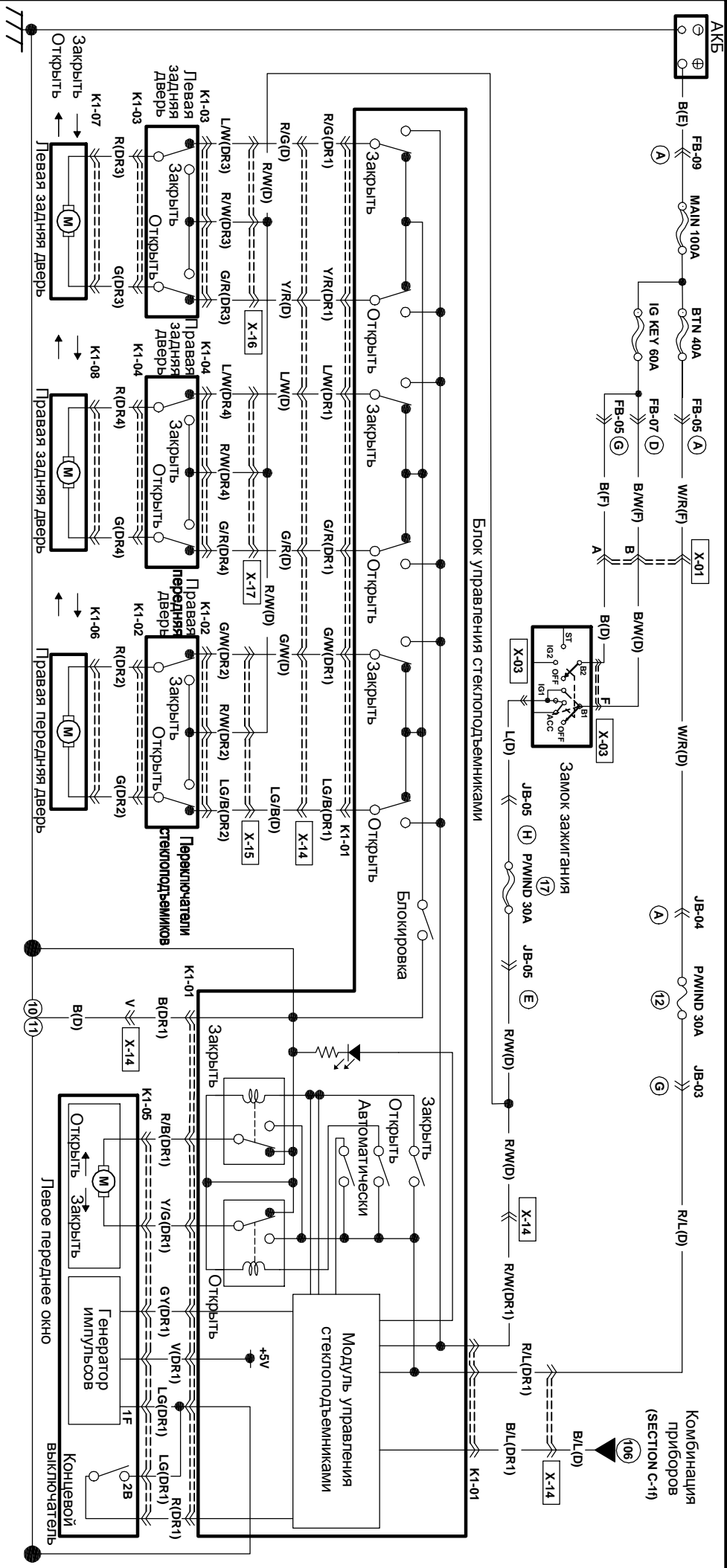

Блок управления стеклоподъемниками

Комбинация приборов (SECTION C-14)

| | | | | | | | | | | | | | | | | | | | | | | | | | | | | | | | | | | | | | | | | | | | | | | | | | | | |
|-----------------------------|-----------------------------|-----------------------------|--|----|------|-----|-----|-----|----|---|-----|-----|-----|--|--|--|-----|------|---|---|---|----|-----|-----|---|---|---|----|---|-----|-----|---|---|---|----|----|----|---|---|-----|---|----|----|---|-----|---|----|--|--|--|--|
| <p>K1-06 ??????????DR2?</p> | <p>K1-07 ??????????DR3?</p> | <p>K1-08 ??????????DR4?</p> | <p>K1-01 ??????????DR1?</p> <table border="1"> <tr><td>GW</td><td>Lg/B</td><td>R/L</td></tr> <tr><td>B/L</td><td>G/R</td><td>LW</td></tr> <tr><td>B</td><td>R/W</td><td>Y/R</td></tr> <tr><td>R/G</td><td></td><td></td></tr> </table> | GW | Lg/B | R/L | B/L | G/R | LW | B | R/W | Y/R | R/G | | | <p>K1-02 ??????????DR2?</p> <table border="1"> <tr><td>R/W</td><td>Lg/B</td><td>*</td><td>G</td><td>R</td><td>GW</td></tr> <tr><td>R/W</td><td>G/R</td><td>*</td><td>G</td><td>R</td><td>LW</td></tr> </table> | R/W | Lg/B | * | G | R | GW | R/W | G/R | * | G | R | LW | <p>K1-03 ??????????DR3?</p> <table border="1"> <tr><td>R/W</td><td>G/R</td><td>*</td><td>G</td><td>R</td><td>LW</td></tr> </table> <p>K1-04 ??????????DR4?</p> <table border="1"> <tr><td>GV</td><td>LG</td><td>R</td><td>V</td></tr> </table> <p>K1-05 ??????????DR1?</p> <table border="1"> <tr><td>Y/G</td><td>Y</td><td>GV</td><td>LG</td><td>*</td><td>R/B</td></tr> <tr><td>R</td><td>LG</td><td></td><td></td><td></td><td></td></tr> </table> | R/W | G/R | * | G | R | LW | GV | LG | R | V | Y/G | Y | GV | LG | * | R/B | R | LG | | | | |
| GW | Lg/B | R/L | | | | | | | | | | | | | | | | | | | | | | | | | | | | | | | | | | | | | | | | | | | | | | | | | |
| B/L | G/R | LW | | | | | | | | | | | | | | | | | | | | | | | | | | | | | | | | | | | | | | | | | | | | | | | | | |
| B | R/W | Y/R | | | | | | | | | | | | | | | | | | | | | | | | | | | | | | | | | | | | | | | | | | | | | | | | | |
| R/G | | | | | | | | | | | | | | | | | | | | | | | | | | | | | | | | | | | | | | | | | | | | | | | | | | | |
| R/W | Lg/B | * | G | R | GW | | | | | | | | | | | | | | | | | | | | | | | | | | | | | | | | | | | | | | | | | | | | | | |
| R/W | G/R | * | G | R | LW | | | | | | | | | | | | | | | | | | | | | | | | | | | | | | | | | | | | | | | | | | | | | | |
| R/W | G/R | * | G | R | LW | | | | | | | | | | | | | | | | | | | | | | | | | | | | | | | | | | | | | | | | | | | | | | |
| GV | LG | R | V | | | | | | | | | | | | | | | | | | | | | | | | | | | | | | | | | | | | | | | | | | | | | | | | |
| Y/G | Y | GV | LG | * | R/B | | | | | | | | | | | | | | | | | | | | | | | | | | | | | | | | | | | | | | | | | | | | | | |
| R | LG | | | | | | | | | | | | | | | | | | | | | | | | | | | | | | | | | | | | | | | | | | | | | | | | | | |

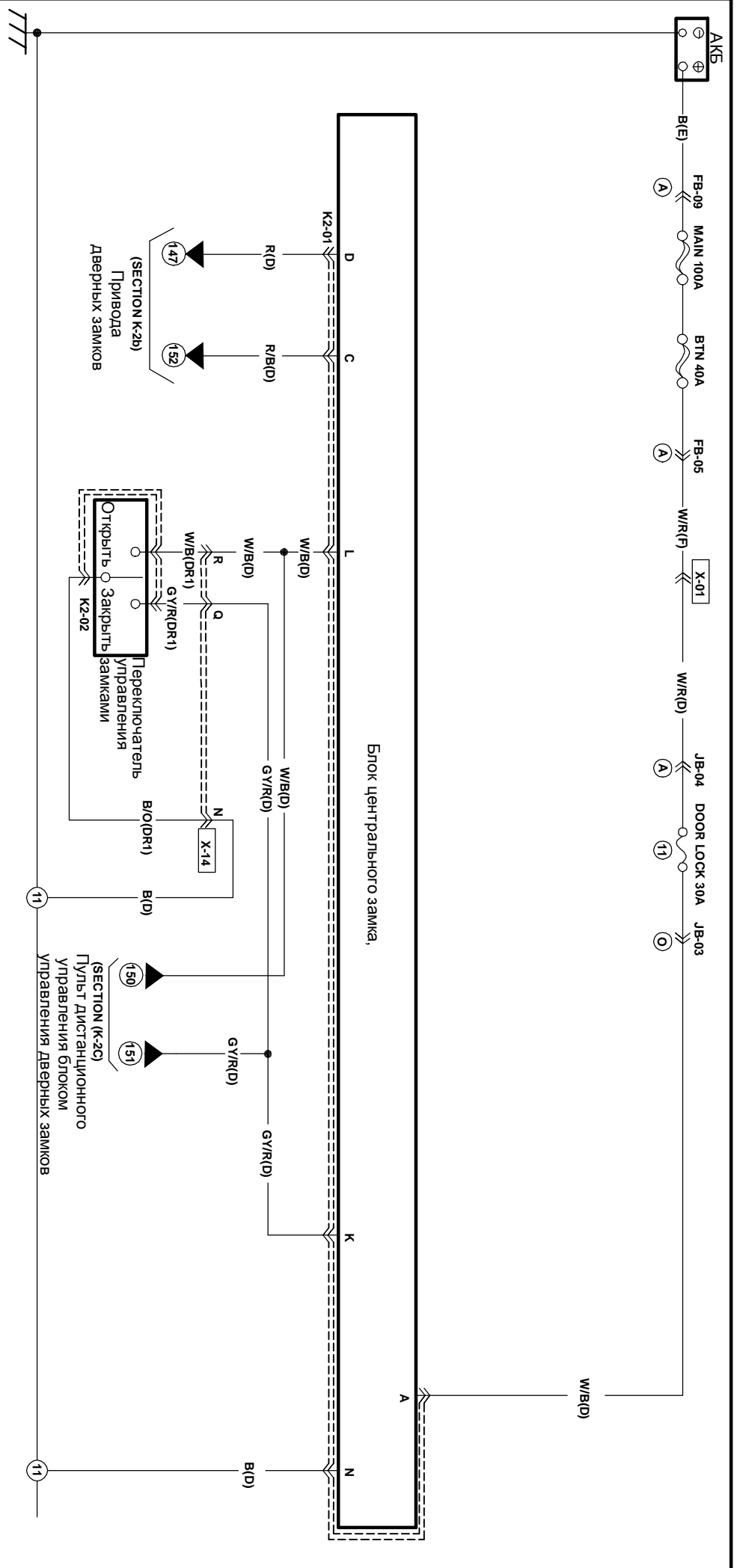

K2-01 ??????(D)

K2-02 ??????(DR1)

| | | | | |
|---|-------|---|-------|-------|
| M | K | I | C | A |
| * | г/у/г | * | г/у/г | г/у/г |
| B | W/B | * | R/B | W/B |
| | | * | R | * |
| N | L | J | H | F |
| | | | D | B |

| | | |
|-----|-------|--|
| W/B | г/у/г | |
| R/B | R | |
| B/O | | |

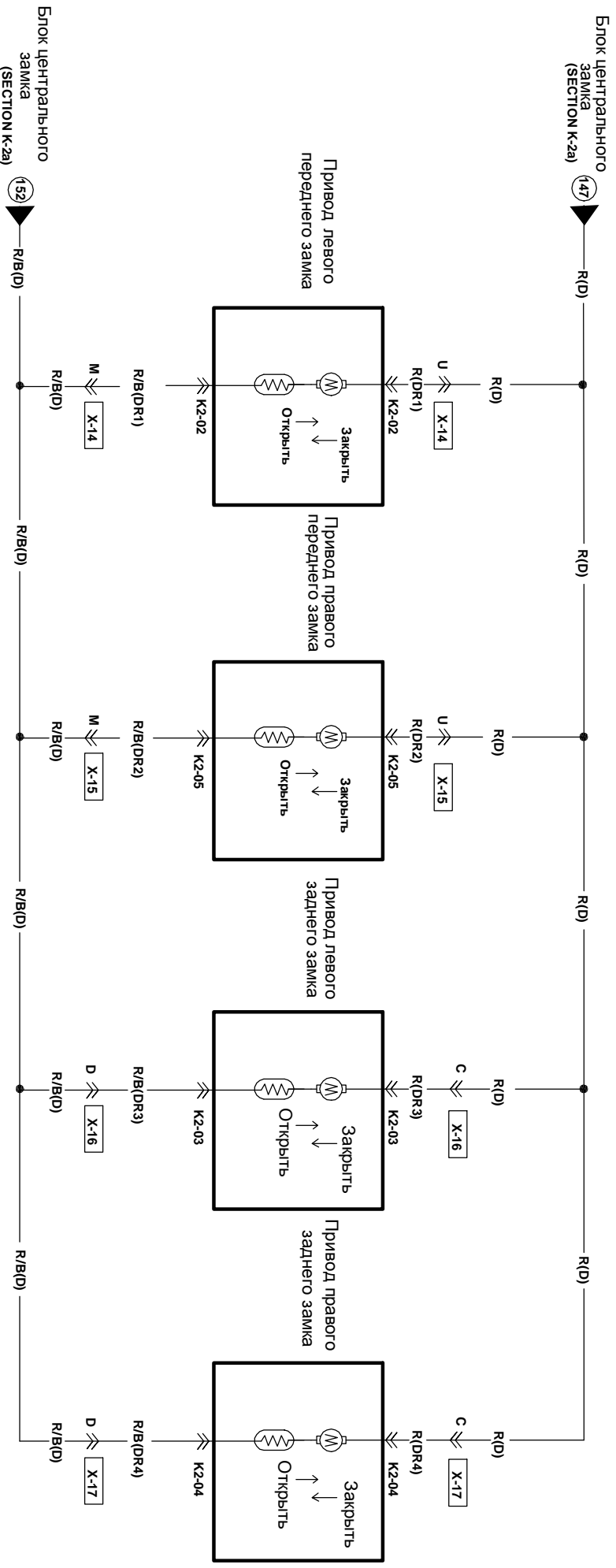

K2-02 Левый передний привод замка (DR1)

| | | |
|-------------------------------------|-----|------|
| <input type="checkbox"/> | W/B | GY/R |
| <input checked="" type="checkbox"/> | R/B | R |
| <input checked="" type="checkbox"/> | B/O | |
| | * | |

K2-03 Правый передний привод замка (DR3)

| | | |
|-------------------------------------|-----|---|
| <input type="checkbox"/> | GY | B |
| <input checked="" type="checkbox"/> | R/B | R |
| <input checked="" type="checkbox"/> | R/Y | * |
| | | |

K2-04 Левый задний привод замка (DR4)

| | | |
|-------------------------------------|-----|---|
| <input type="checkbox"/> | GY | B |
| <input checked="" type="checkbox"/> | R/B | R |
| <input checked="" type="checkbox"/> | R/Y | * |
| | | |

K2-05 Правый задний привод замка (DR2)

| | | | |
|-------------------------------------|-----|---|-------------------------------------|
| <input type="checkbox"/> | | | <input checked="" type="checkbox"/> |
| <input checked="" type="checkbox"/> | * | * | |
| <input checked="" type="checkbox"/> | R/B | R | |
| <input checked="" type="checkbox"/> | * | * | |

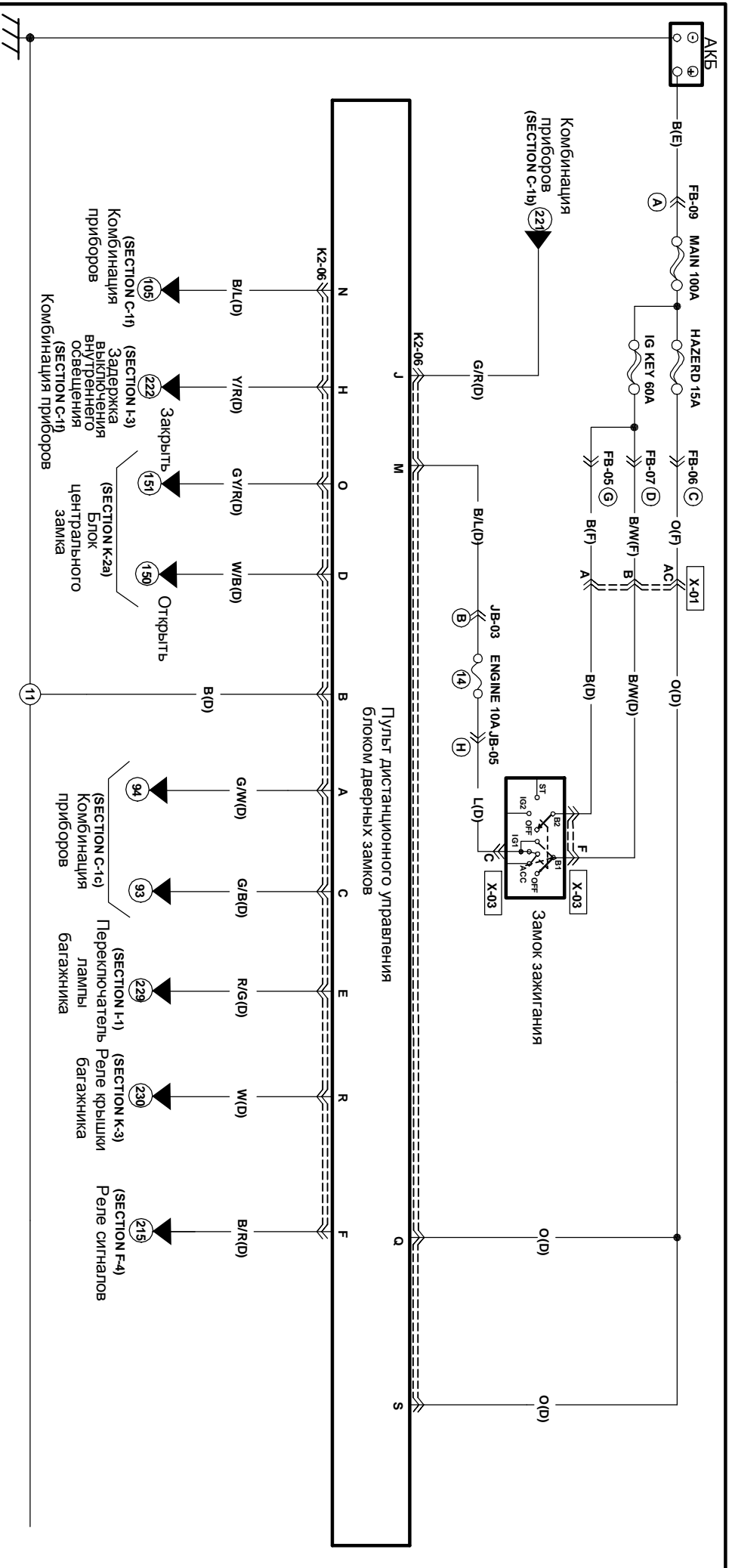

K2-06 Блок центрального замка (D)

| | | | | | | | | | |
|---|---|-------|-----|---|---|-----|-----|-----|-----|
| S | Q | O | M | K | I | G | E | C | A |
| O | O | G/Y/R | V/L | * | * | R/G | G/B | G/W | |
| * | W | * | V/L | * | * | G/R | V/R | B/R | W/B |
| T | R | R | N | L | J | H | F | D | B |

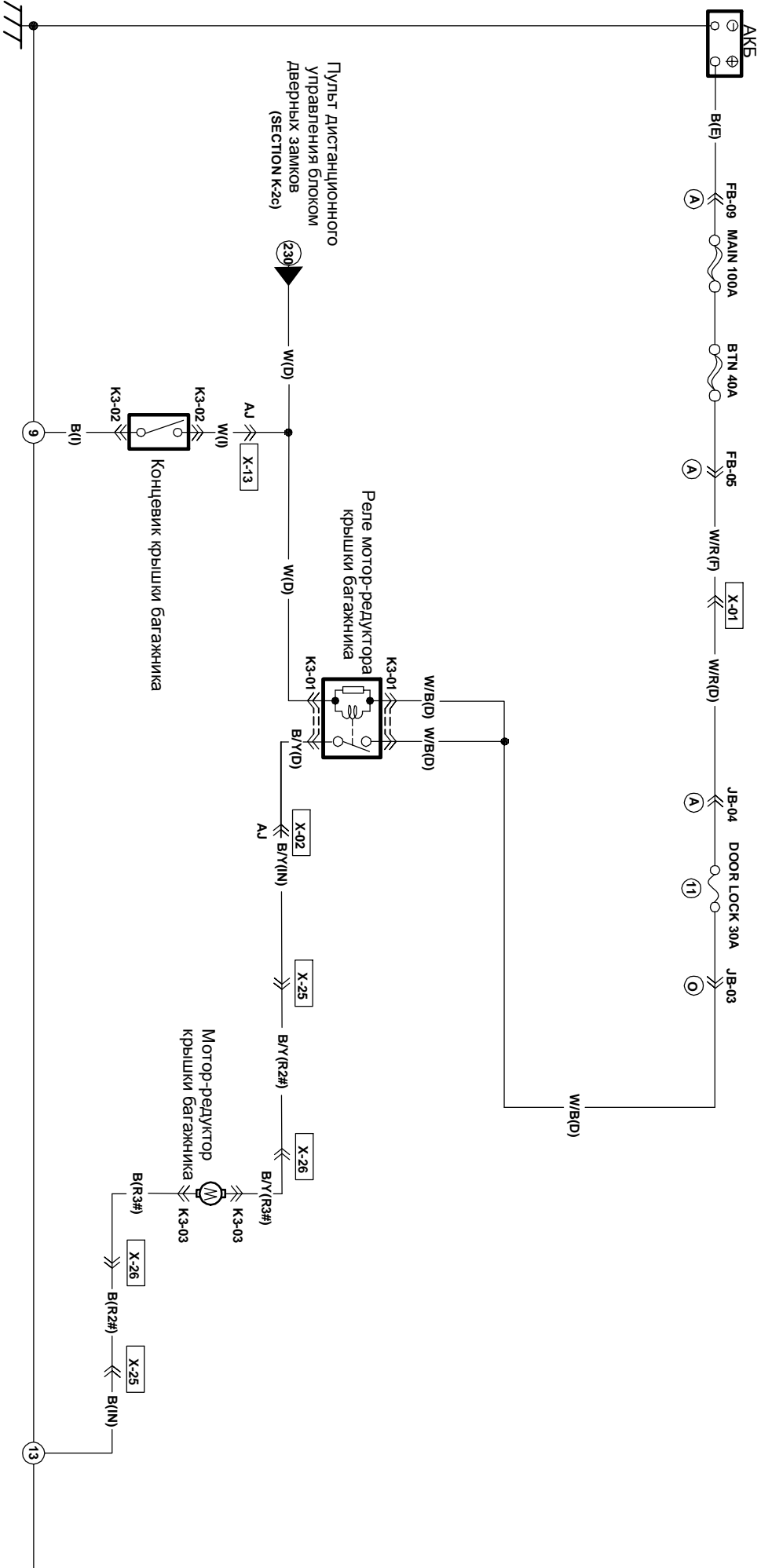

К3-01 ?????????(D)

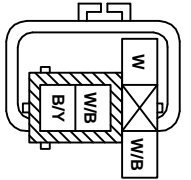

К3-02 ???????(I)

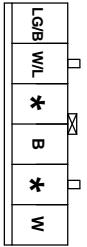

К3-03 ?????????(R3#)



Мотор-регулятор крышки багажника (Хечбек)

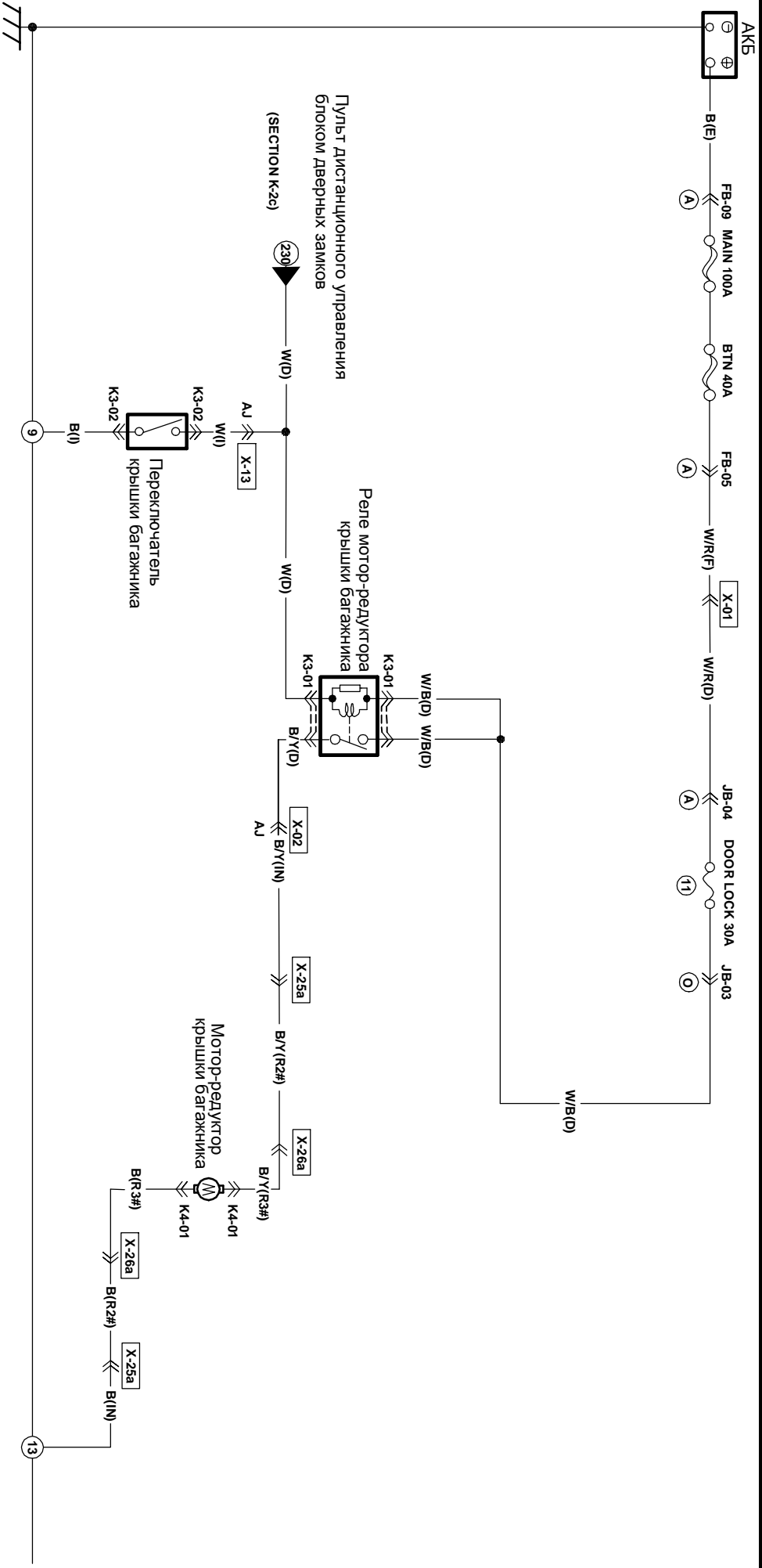

K3-01 ??????(D)

K3-02 ??????(I)

K4-01 ??????(R3#)

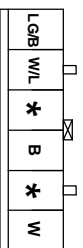
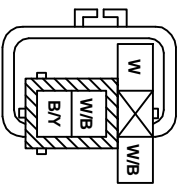

Обогреватель зеркал заднего вида / Электропривод наружных зеркал

L

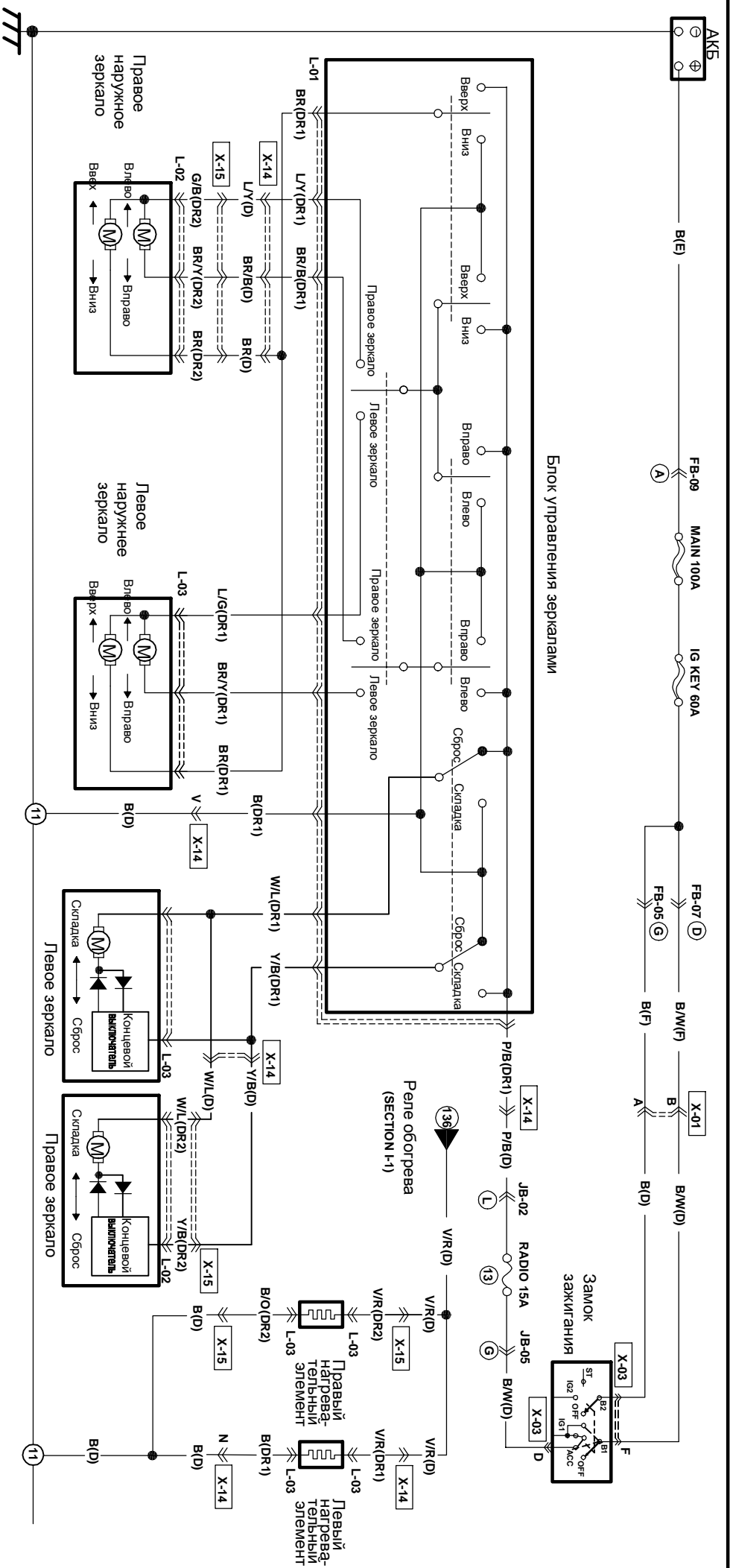

L-01 Переключаемая зеркал заднего вида (DR1)

| | | | | |
|------|----|----|-----|-----|
| BR/B | BR | | * | Y/B |
| BR/Y | LY | LG | P/B | B |
| | | | | W/L |

L-02 Правое зеркало заднего вида (DR2)

| | | | |
|-----|-----|-----|------|
| V/R | W/L | * | Y/B |
| GW | BR | G/B | BR/Y |
| | | | BR/O |

L-03 Левое зеркало заднего вида (DR1)

| | | | |
|-----|-----|----|------|
| V/R | W/L | * | Y/B |
| G/B | BR | LG | BR/Y |
| | | | B |

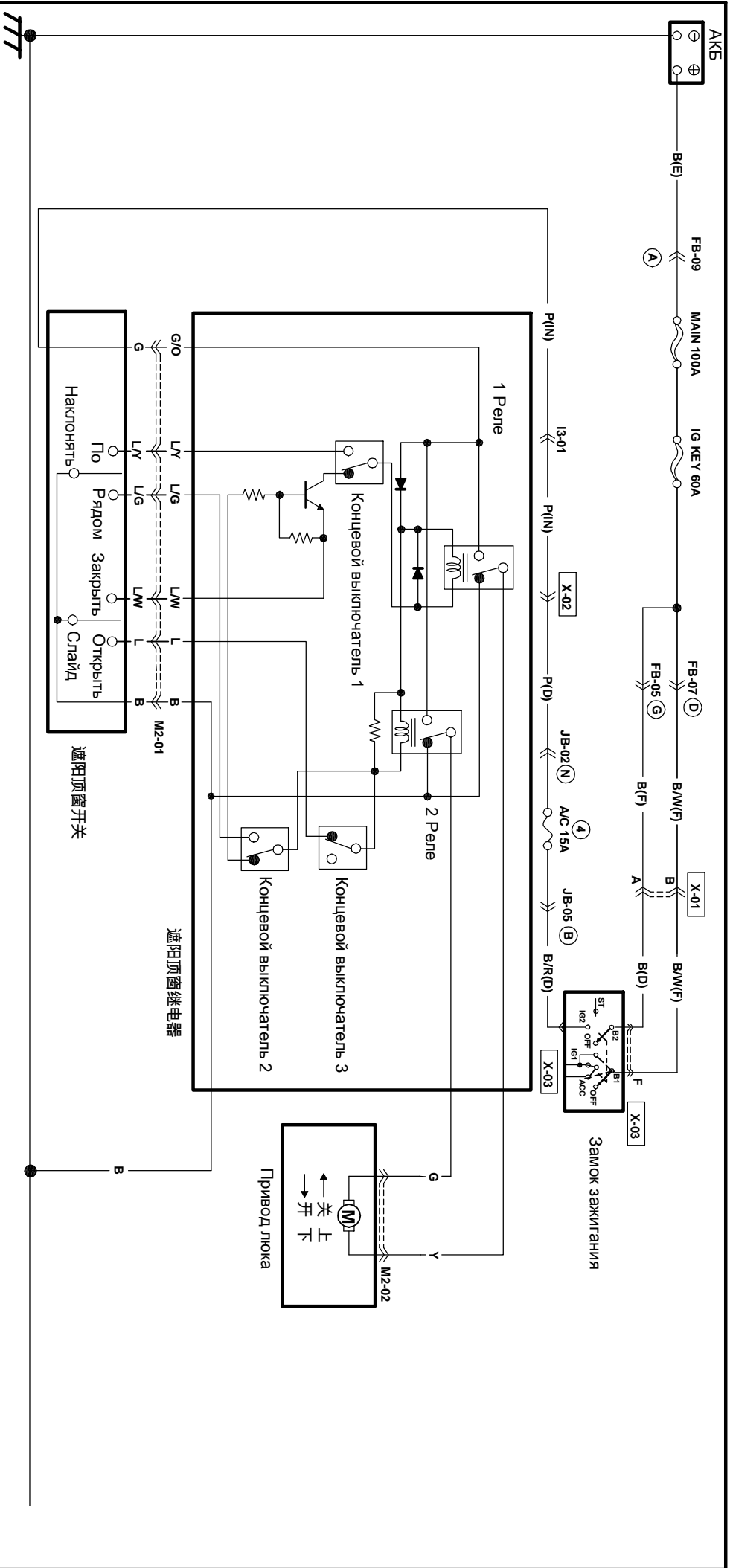

| | | | | |
|----------------------|----------------|------------------|--|--|
| M2-01 ?????????????? | M2-02 ???????? | I3-01 ???????(N) | | |
|----------------------|----------------|------------------|--|--|

| | | |
|----|----|----|
| LG | LW | G |
| B | L | LV |

| | | |
|----|----|----|
| LG | LW | LG |
| LV | L | B |

| | |
|---|-----|
| P | LR |
| B | Y/R |

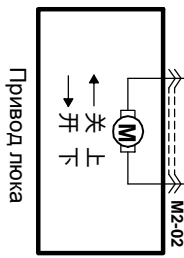

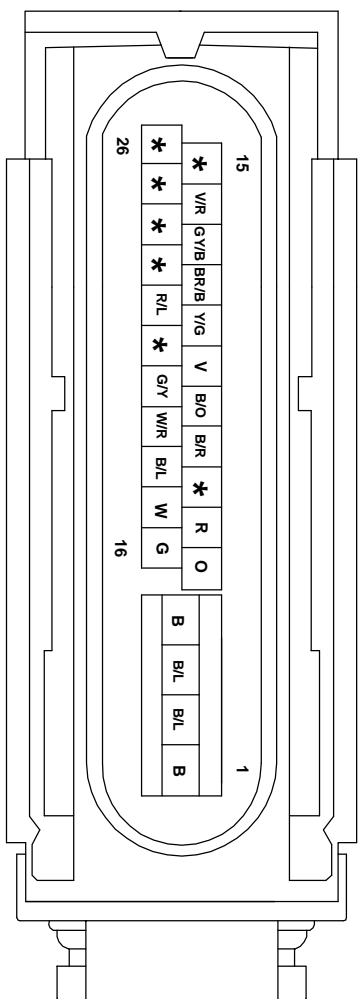
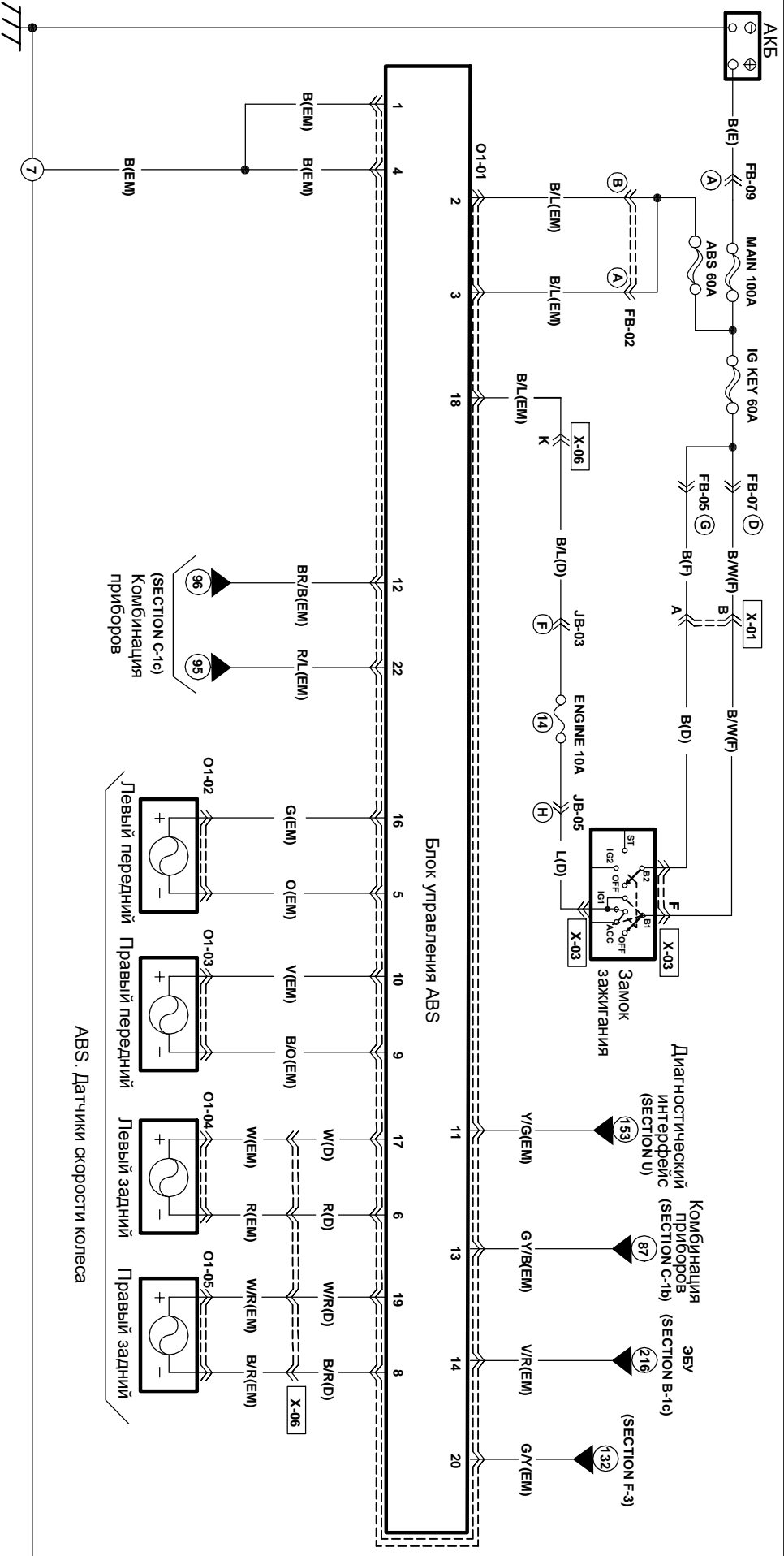

| | | | | |
|-----------------------------|--|-----------------------------|--|--|
| 01-02 ABS???? ? (EM) | | 01-03 ABS???? ? (EM) | | |
| 01-04 ABS???? ? (D) | | 01-05 ABS???? ? (D) | | |

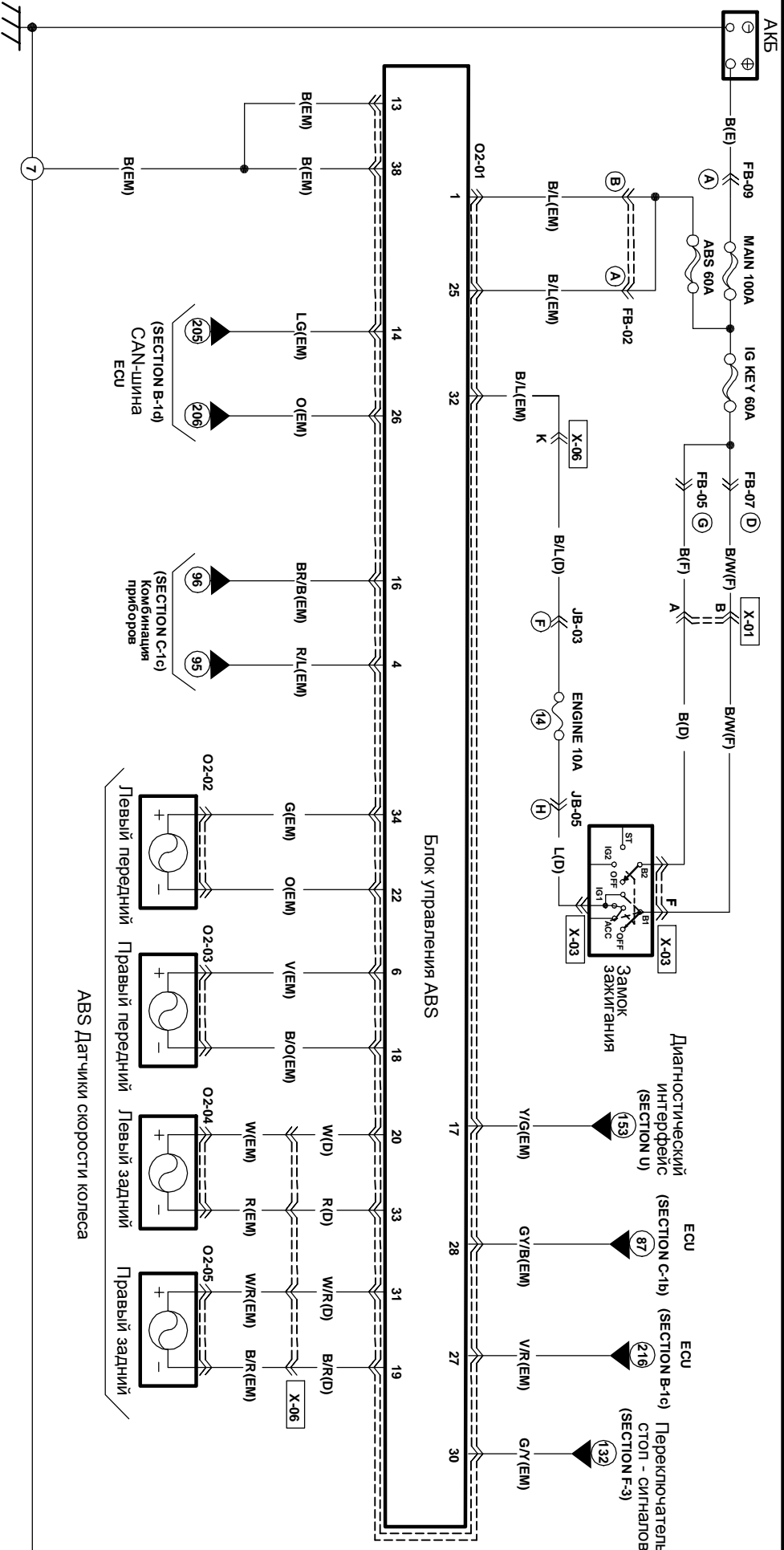

02-01 ABS??? (EM)

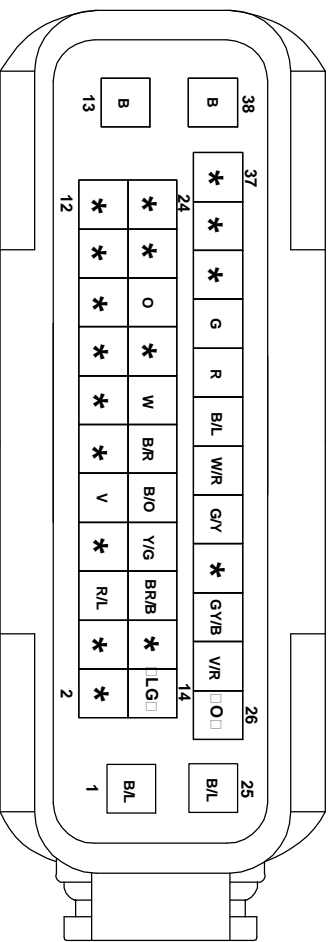

02-02 ABS??? (EM)

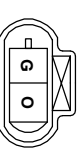

02-03 ABS??? (EM)

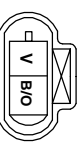

02-04 ABS??? (D)



02-05 ABS??? (D)

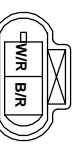

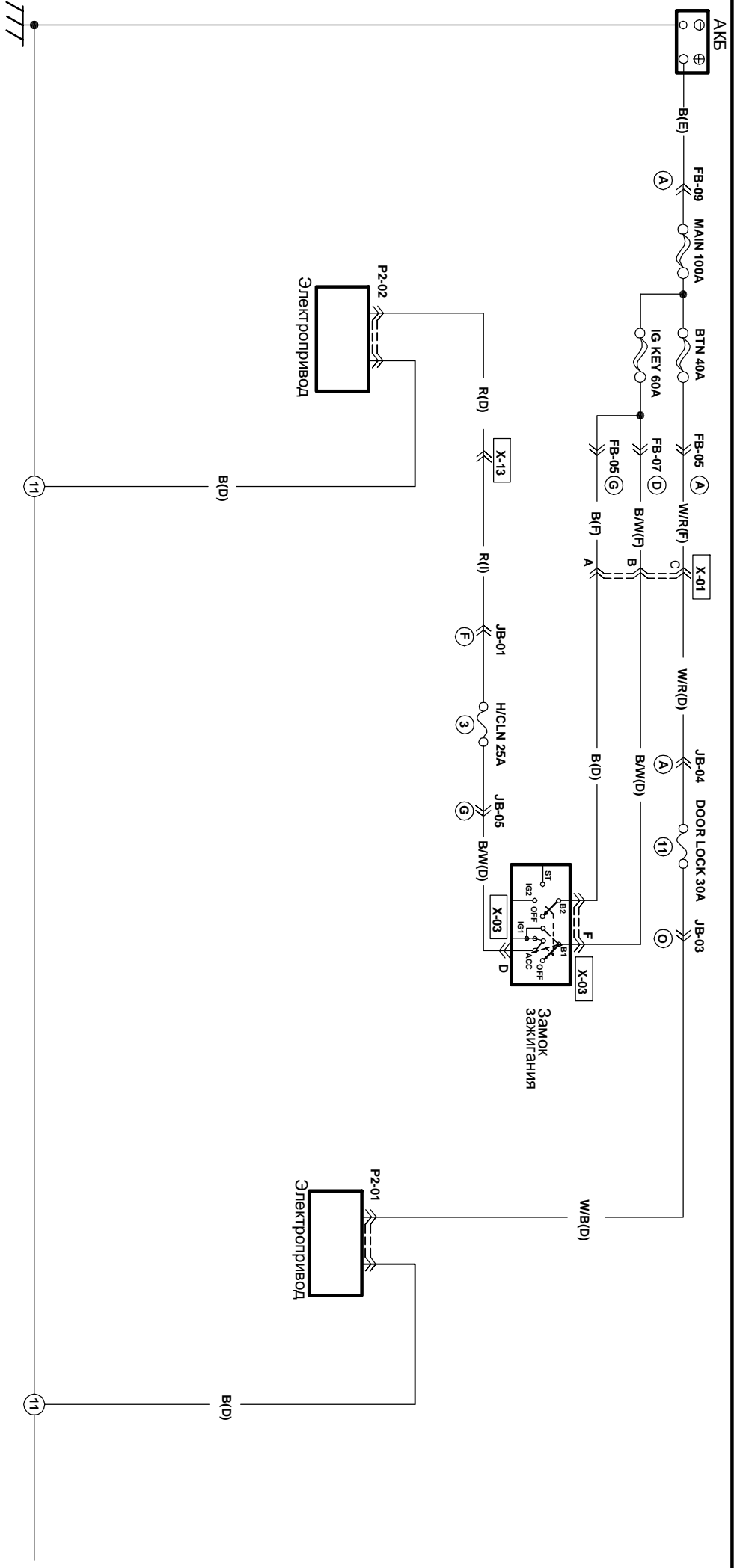

| | | | | | |
|---------------|----------------|--|--|--|--|
| P2-01 ????(D) | P2-02 ?????(D) | | | | |
| | | | | | |
| | | | | | |
| | | | | | |
| | | | | | |
| | | | | | |

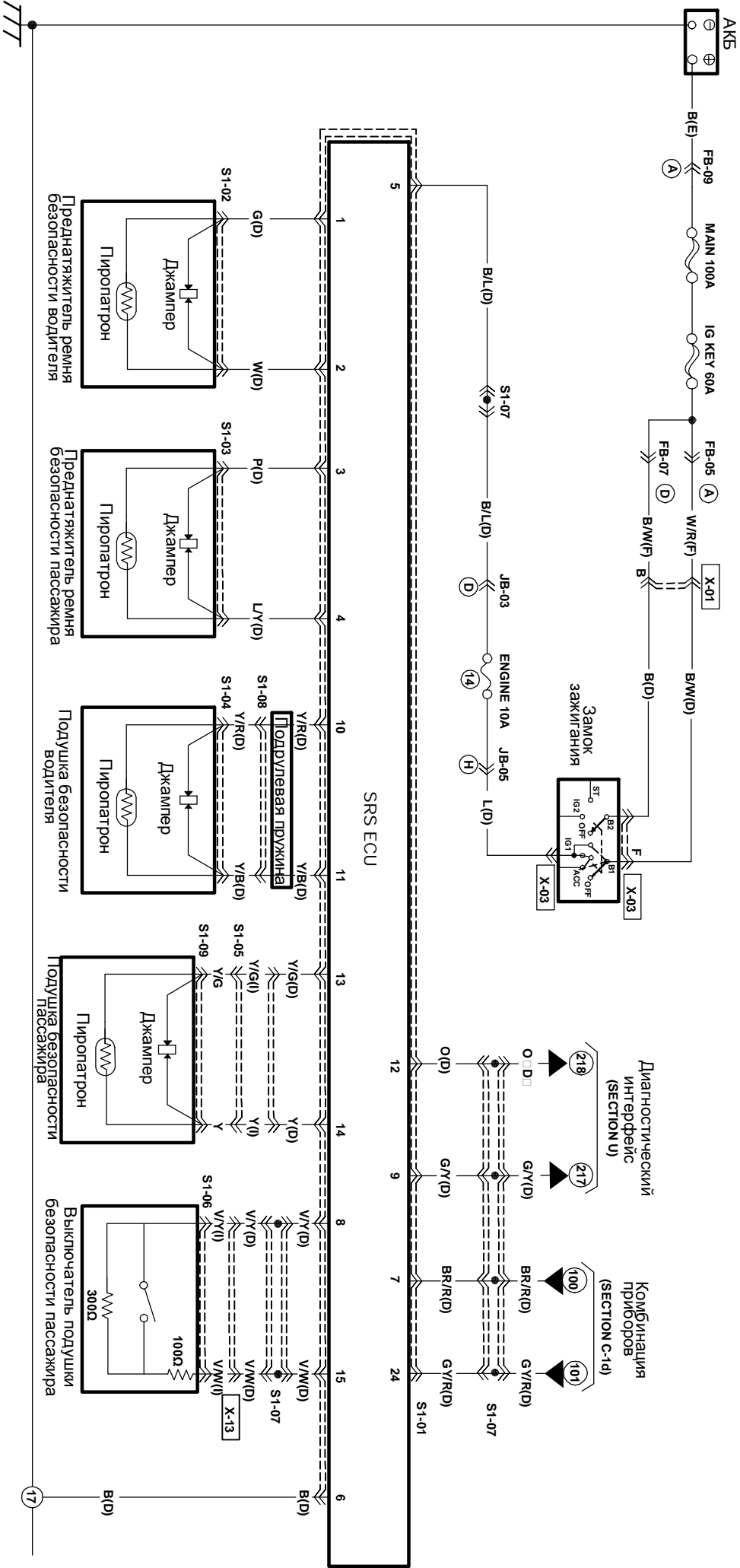

S1-01 Блок ECU(D)

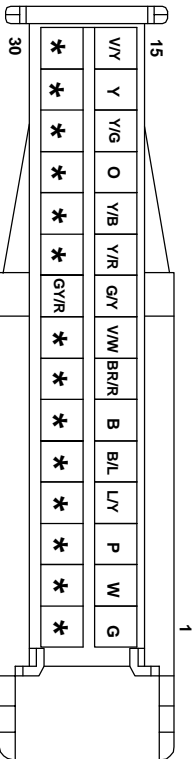

| | | | |
|--------------------|--------------------|------------------|------------------|
| S1-02 ?????????(D) | S1-03 ?????????(D) | S1-04 ???????? | S1-05 ???????(1) |
| | | | |
| S1-06 ?????????(1) | S1-07 ?????????(D) | S1-08 ???????(D) | |
| | | | |
| S1-09 ???????? | | | |
| | | | |

Диагностический интерфейс (DLC)

U

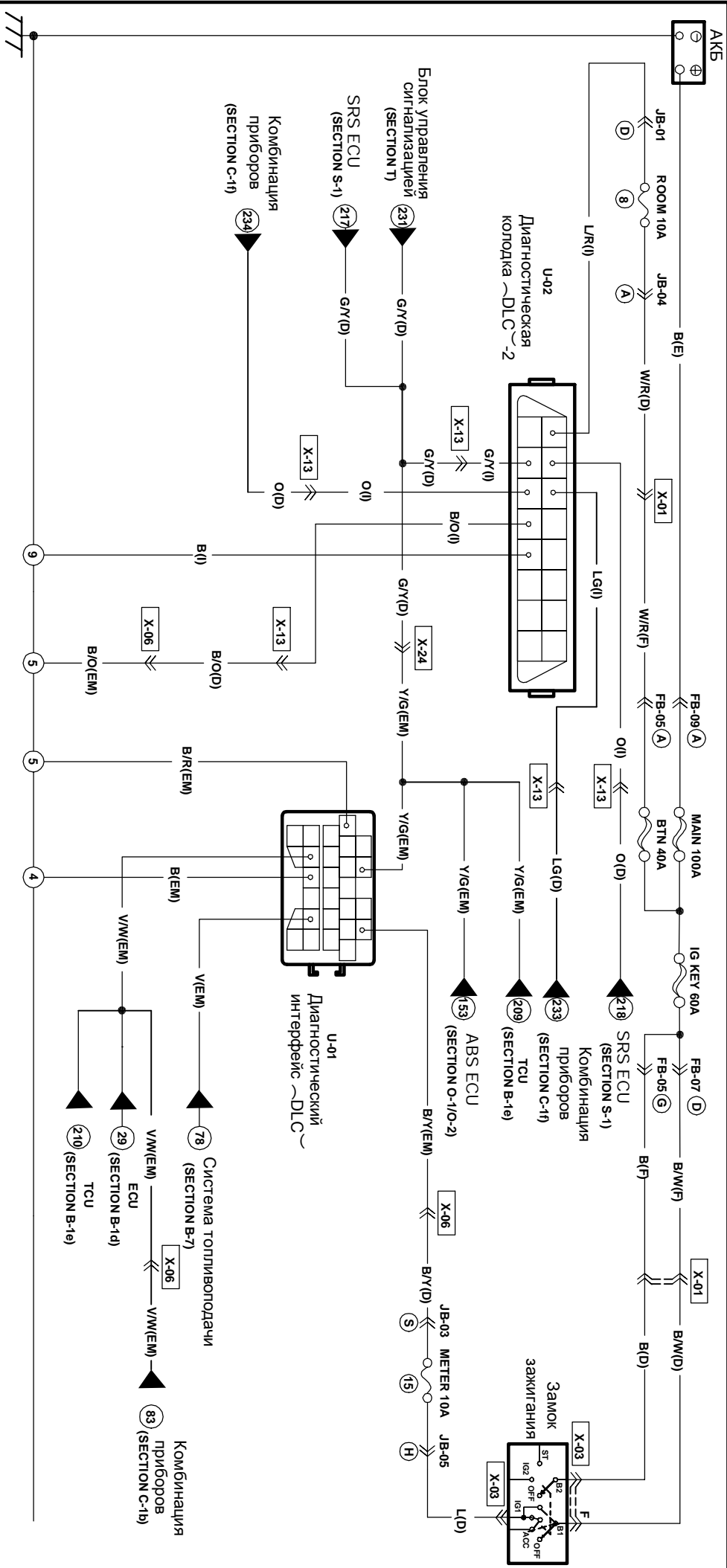

U-01 Диагностический интерфейс (DLC) (ЭМ)

| | | | | | |
|-----|---|-----|---|-----|---|
| B/R | * | G/Y | * | B/V | * |
| * | * | * | * | * | * |
| * | * | * | * | * | * |
| V/W | * | B | * | V | * |
| * | * | * | * | * | * |

????????????????

U-02 Диагностический интерфейс (DLC) - 2 (!)

| | | | | | |
|-----|---|-----|---|---|---|
| LR | 0 | LG | * | * | * |
| G/Y | 0 | B/O | * | * | * |
| * | * | B | * | * | * |
| * | * | * | * | * | * |

????????????????

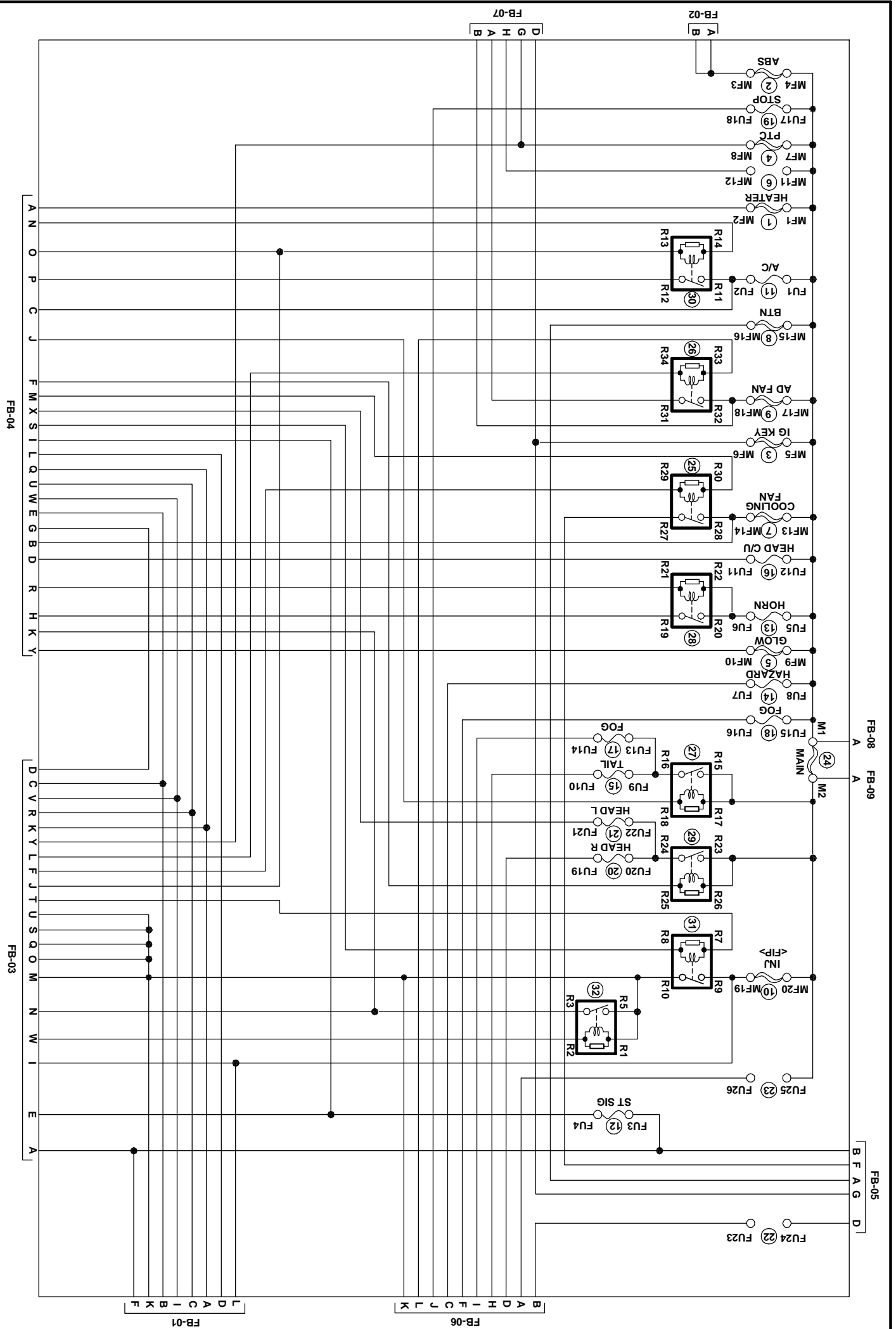

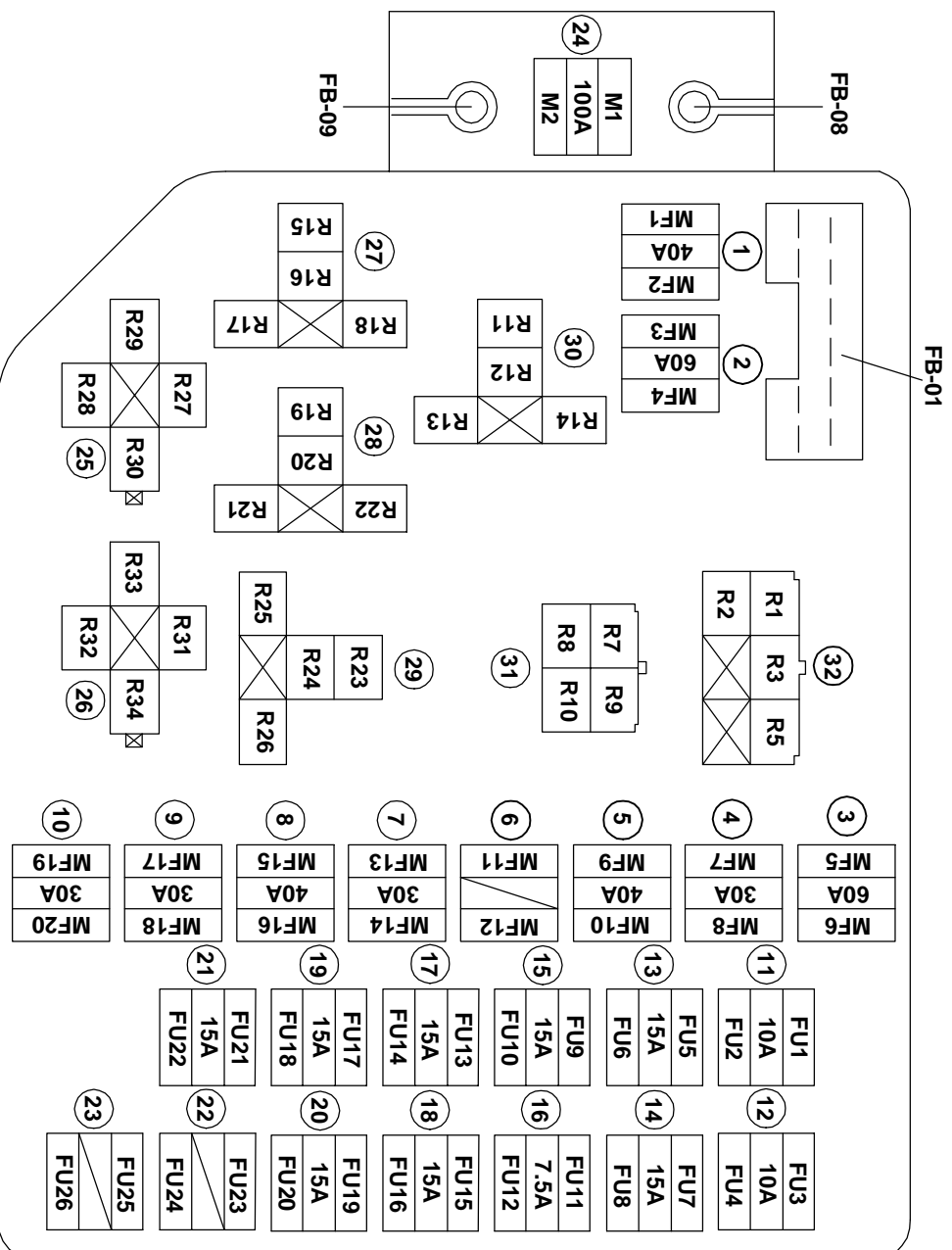

| № | Назначение предохранителей | № | Назначение предохранителей |
|----|----------------------------|----|----------------------------|
| 1 | Нагреватели | 13 | Звуковые сигналы |
| 2 | ABS | 14 | Аварийка |
| 3 | Замок зажигания | 15 | Задний фонарь |
| 4 | PTC | 16 | Фара контроля |
| 5 | Обогрев | 17 | ПТФ |
| 6 | * | 18 | ПТФ |
| 7 | Охлаждающий вентилятор | 19 | Дополнительный стоп-сигнал |
| 8 | VTN | 20 | Правая фара |
| 9 | Вентилятор конденсора | 21 | Левая фара |
| 10 | Инжектор | 22 | * |
| 11 | Кондиционер | 23 | * |
| 12 | Начало сигнала | 24 | Главный предохранитель |

| № | Назначение Реле | № | Назначение Реле |
|----|------------------------|----|-----------------|
| 25 | Охлаждающий вентилятор | 30 | Кондиционер |
| 26 | Вентилятор конденсора | 31 | Главное реле |
| 27 | Задний фонарь | 32 | Топливный насос |
| 28 | Звуковые сигналы | | |
| 29 | Фара | | |

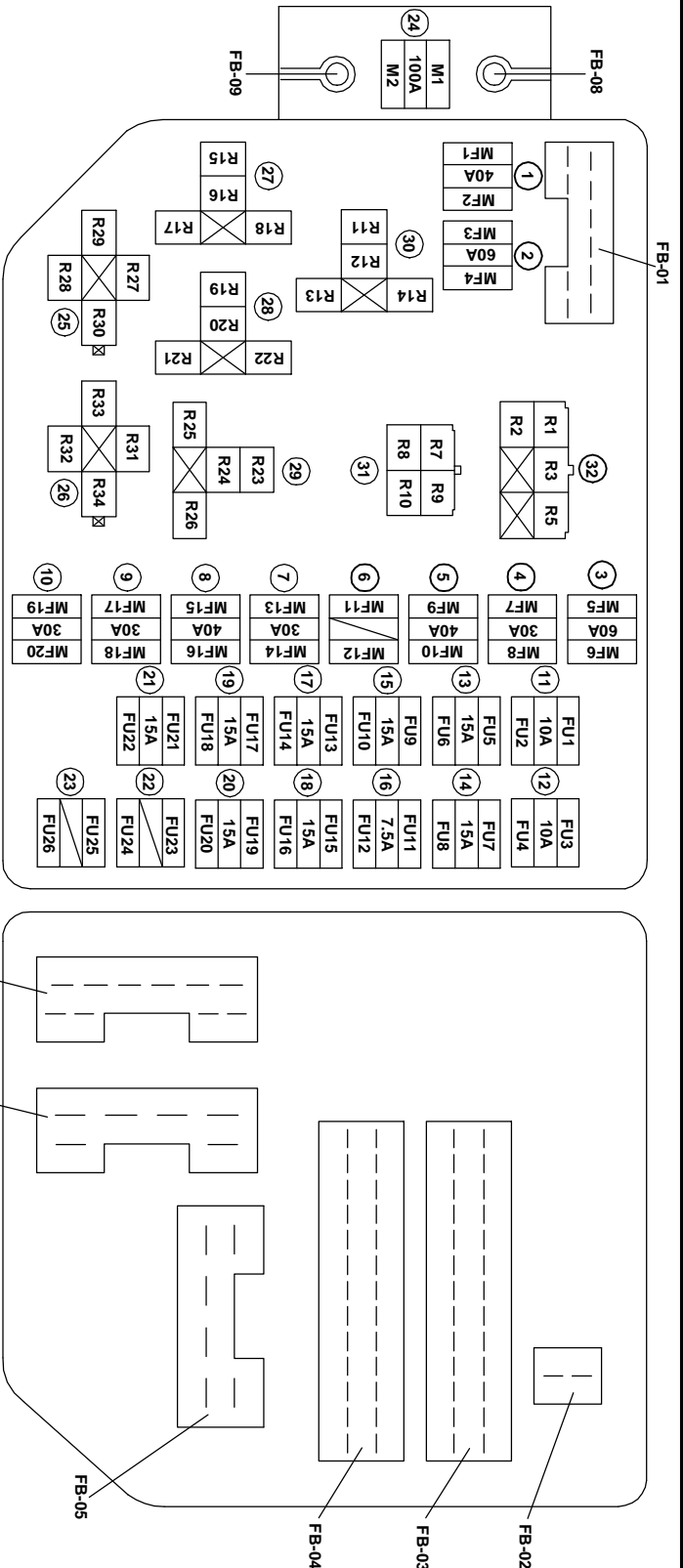

| № | Назначение предохранителей | № | Назначение предохранителей |
|----|----------------------------|----|----------------------------|
| 1 | Нагреватели | 13 | Звуковые сигналы |
| 2 | ABS | 14 | Аварийка |
| 3 | Замок зажигания | 15 | Задний фонарь |
| 4 | PTC | 16 | Фара контроля |
| 5 | Обогрев | 17 | ПТФ |
| 6 | * | 18 | ПТФ |
| 7 | Охлаждающий вентилятор | 19 | Дополнительный стоп-сигнал |
| 8 | ВТН | 20 | Правая фара |
| 9 | Вентилятор конденсора | 21 | Левая фара |
| 10 | Инджектор | 22 | * |
| 11 | Кондиционер | 23 | * |
| 12 | Начало сигнала | 24 | Главный предохранитель |

| № | Назначение Реле | № | Назначение Реле |
|----|------------------------|----|-----------------|
| 25 | Охлаждающий вентилятор | 30 | Кондиционер |
| 26 | Вентилятор конденсора | 31 | Главное реле |
| 27 | Задний фонарь | 32 | Топливный насос |
| 28 | Звуковые сигналы | | |
| 29 | Фара | | |

FB-01 ???????E?

FB-02 EM????EM?

FB-03 EM????EM?

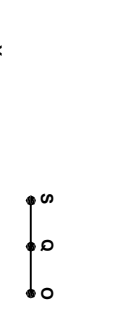
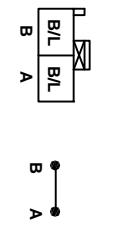
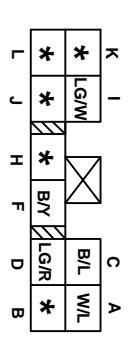

FB-04 ?????F?

FB-05 ?????F?

FB-06 ?????F?

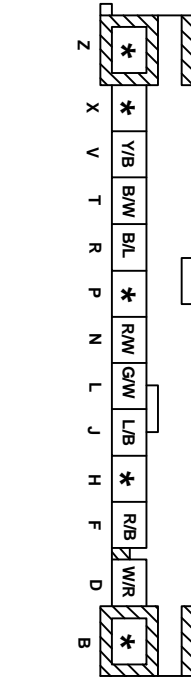
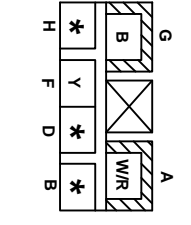
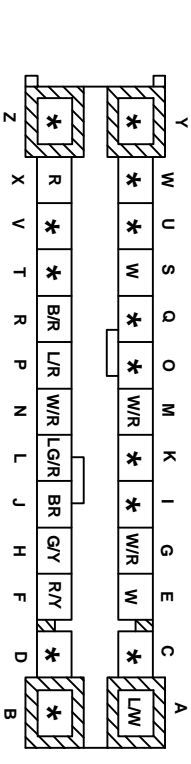



FB-06 ?????F?

FB-07 ?????F?

FB-08 ???????E?

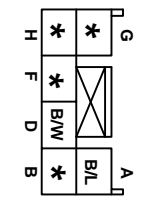
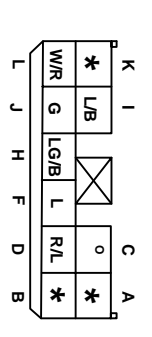
FB-09 ???????E?

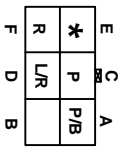
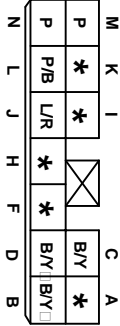
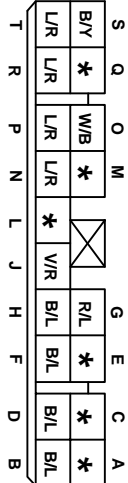

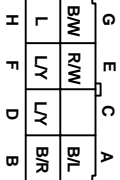
| | |
|--|---|
| <p>JB-01 ???????D?</p>  | <p>JB-02 ???????D?</p>  |
| <p>JB-03 ???????D?</p>  | <p>JB-04 ???????D?</p>  |
| <p>JB-05 ???????D?</p>  | |

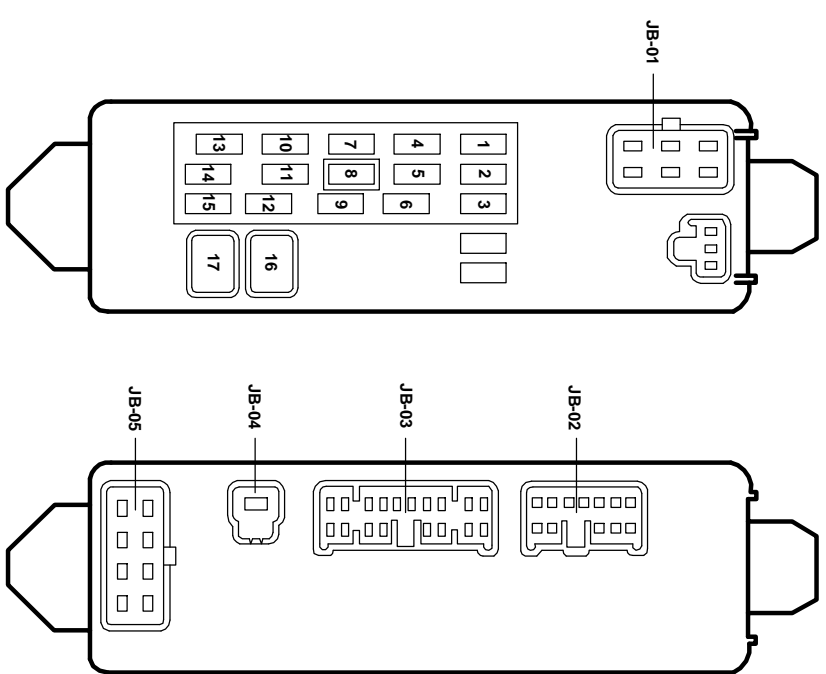

| № | Назначение предохранителей | Номинал | № | Назначение предохранителей | Номинал |
|---|------------------------------|---------|----|--------------------------------|---------|
| 1 | Подогрев сидений | 15А | 10 | — | — |
| 2 | Очиститель фар | 20А | 11 | Центральный замок | 30А |
| 3 | Аудио система | 15А | 12 | Электрические стеклоподъемники | 30А |
| 4 | Кондиционер | 15А | 13 | Стеклоочистители | 20А |
| 5 | Задний стеклоочиститель | 10А | 14 | Двигатель | 10А |
| 6 | — | — | 15 | Метр | 10А |
| 7 | — | — | 16 | — | — |
| 8 | Люк крышки | 10А | 17 | Электрические стеклоподъемники | 30А |
| 9 | Обогрев зеркала заднего вида | 10А | | | |

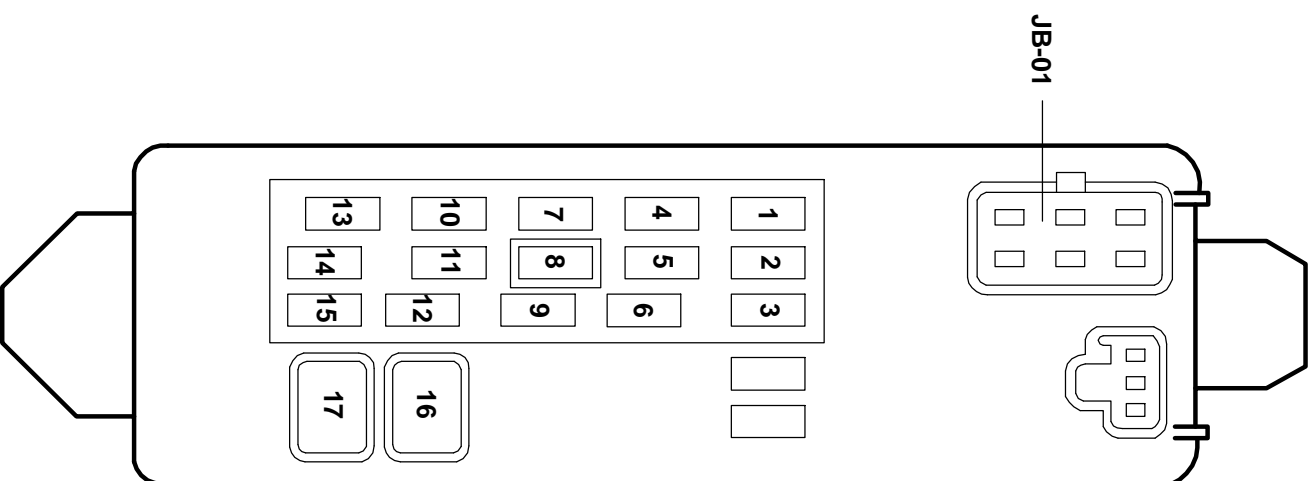

| № | Назначение предохранителей | Номинал | № | Назначение предохранителей | Номинал |
|----------|-----------------------------------|----------------|----------|-----------------------------------|----------------|
| 1 | Подогрев сидений | 15А | 10 | _____ | _____ |
| 2 | Очиститель фар | 20А | 11 | Центральный замок | 30А |
| 3 | Аудио система | 15А | 12 | Электрические стеклоподъемники | 30А |
| 4 | Кондиционер | 15А | 13 | Стеклоочистители | 20А |
| 5 | Задний стеклоочиститель | 10А | 14 | Двигатель | 10А |
| 6 | _____ | _____ | 15 | Метр | 10А |
| 7 | _____ | _____ | 16 | _____ | _____ |
| 8 | ЛЮК КРЫШИ | 10А | 17 | Электрические стеклоподъемники | 30А |
| 9 | Обогрев зеркала заднего вида | 10А | | | |